

SCHEMA DE PRINCIPE VEHICULE ELECTRIQUE

M 49

"M 49 TDS "

ETAT DEFINITIF N° 3

POUR
FABRICATION

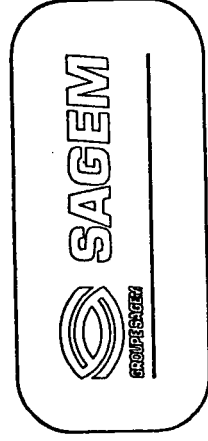

BODY CONTROLEUR_BT !!!

CARTE_CPUBT

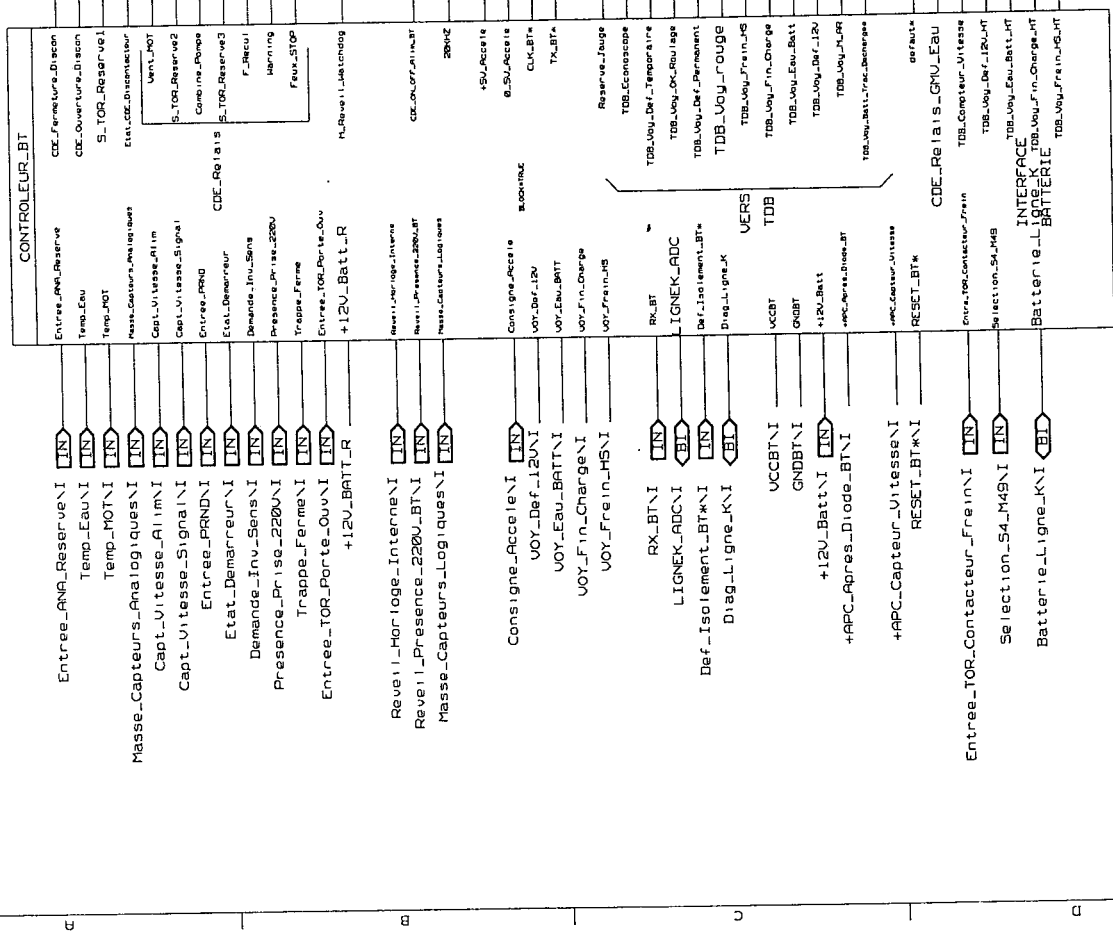

**VALABLE
POUR FABRICATION**

M49 SERIE TDS

SOCIETE D'APPLICATIONS GENERALES D'ELECTRICITE		REVISION 3 SUR 37	
SCHEMA DE PRINCIPLE		SCHEMA DE PRINCIPLE	
ETABL:	NOM:	REF:	PRE:
RI BCS	09/93		
DESIGNATION		FORMAT A2	
CARTE CALCULATEUR		CI CPU BT	
NOMBRE DE DOCUMENT		21622082	
IND		82	

IND	DATE	REVISIONS-CORRECTIONS
F	12/95	
F	11/96	
F	04/97	

DRAWING:
TITLE: CPU BT
ABBREVIATION:

Med Mar 5 10: 10: 29 1997

1

* 5 Tops/m *

CE DOCUMENT EST LA PROPRIETE DE LA SOCIETE IL NE PEUT ETRE REPRODUIT OU COMMUNIQUE SANS AUTORISATION CENTRE

142723-2

CARTE_CPUBT

SCHEMA DE PRINCIPLE		SCHEMA DE PRINCIPLE	
GENERALES D'ALIMENTATION	ET DE REGULATION	CARTE-CALCULATEUR	
REVISION 4 SUR 37		CI-CPU-BT	
NUMERO DE DOCUMENT		IND.	
2162208219 B2		B2	

SCHEMA DE PRINCIPLE		SCHEMA DE PRINCIPLE	
GENERALES D'ALIMENTATION	ET DE REGULATION	CARTE-CALCULATEUR	
REVISION 4 SUR 37		CI-CPU-BT	
NUMERO DE DOCUMENT		IND.	
2162208219 B2		B2	

SCHEMA DE PRINCIPLE		SCHEMA DE PRINCIPLE	
GENERALES D'ALIMENTATION	ET DE REGULATION	CARTE-CALCULATEUR	
REVISION 4 SUR 37		CI-CPU-BT	
NUMERO DE DOCUMENT		IND.	
2162208219 B2		B2	

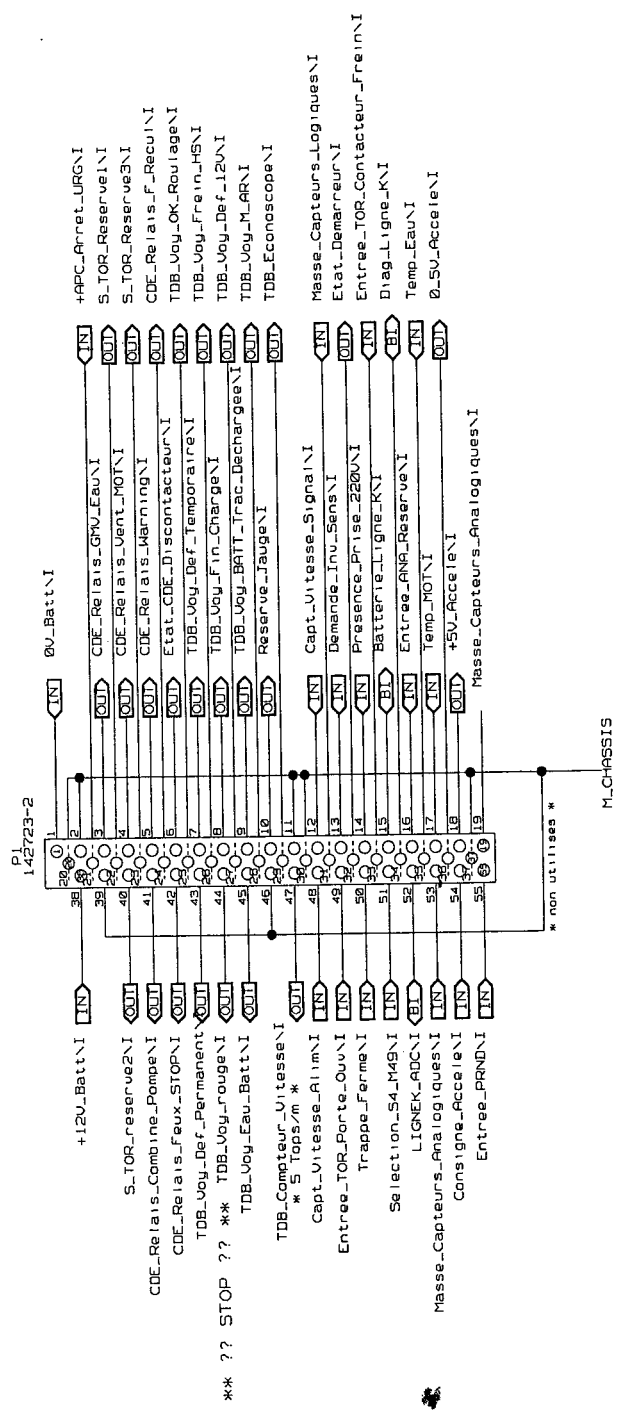

VALABLE
POUR FABRICATION

M49 SERIE TDS

2

DRAWING:
TABLE-CPUBT
ABREVEVEMENT

IND DATE
B2 04/97
B1 11/96
B 12/95

REVISIONS-CORRECTIONS
FORMAT A2

DESIGNATION
CI-CPU-BT

SCHEMA DE PRINCIPLE

ET DE REGULATION

REVISION 4 SUR 37

NUMERO DE DOCUMENT

IND. B2

2162208219

SCHEMA DE PRINCIPLE

ET DE REGULATION

REVISION 4 SUR 37

NUMERO DE DOCUMENT

IND. B2

2162208219

SCHEMA DE PRINCIPLE

ET DE REGULATION

REVISION 4 SUR 37

NUMERO DE DOCUMENT

IND. B2

2162208219

SCHEMA DE PRINCIPLE

ET DE REGULATION

REVISION 4 SUR 37

NUMERO DE DOCUMENT

IND. B2

2162208219

SCHEMA DE PRINCIPLE

ET DE REGULATION

REVISION 4 SUR 37

NUMERO DE DOCUMENT

IND. B2

2162208219

SCHEMA DE PRINCIPLE

ET DE REGULATION

REVISION 4 SUR 37

NUMERO DE DOCUMENT

IND. B2

2162208219

SCHEMA DE PRINCIPLE

ET DE REGULATION

REVISION 4 SUR 37

NUMERO DE DOCUMENT

IND. B2

2162208219

SCHEMA DE PRINCIPLE

ET DE REGULATION

REVISION 4 SUR 37

NUMERO DE DOCUMENT

IND. B2

2162208219

SCHEMA DE PRINCIPLE

ET DE REGULATION

REVISION 4 SUR 37

NUMERO DE DOCUMENT

IND. B2

2162208219

SCHEMA DE PRINCIPLE

ET DE REGULATION

REVISION 4 SUR 37

NUMERO DE DOCUMENT

IND. B2

2162208219

SCHEMA DE PRINCIPLE

ET DE REGULATION

REVISION 4 SUR 37

NUMERO DE DOCUMENT

IND. B2

2162208219

SCHEMA DE PRINCIPLE

ET DE REGULATION

REVISION 4 SUR 37

NUMERO DE DOCUMENT

IND. B2

2162208219

SCHEMA DE PRINCIPLE

ET DE REGULATION

REVISION 4 SUR 37

NUMERO DE DOCUMENT

IND. B2

2162208219

SCHEMA DE PRINCIPLE

ET DE REGULATION

REVISION 4 SUR 37

NUMERO DE DOCUMENT

IND. B2

2162208219

SCHEMA DE PRINCIPLE

ET DE REGULATION

REVISION 4 SUR 37

NUMERO DE DOCUMENT

IND. B2

2162208219

SCHEMA DE PRINCIPLE

ET DE REGULATION

REVISION 4 SUR 37

NUMERO DE DOCUMENT

IND. B2

2162208219

SCHEMA DE PRINCIPLE

ET DE REGULATION

REVISION 4 SUR 37

NUMERO DE DOCUMENT

IND. B2

2162208219

SCHEMA DE PRINCIPLE

ET DE REGULATION

REVISION 4 SUR 37

NUMERO DE DOCUMENT

IND. B2

2162208219

SCHEMA DE PRINCIPLE

ET DE REGULATION

REVISION 4 SUR 37

NUMERO DE DOCUMENT

IND. B2

2162208219

SCHEMA DE PRINCIPLE

ET DE REGULATION

REVISION 4 SUR 37

NUMERO DE DOCUMENT

IND. B2

2162208219

SCHEMA DE PRINCIPLE

ET DE REGULATION

REVISION 4 SUR 37

NUMERO DE DOCUMENT

IND. B2

2162208219

SCHEMA DE PRINCIPLE

ET DE REGULATION

REVISION 4 SUR 37

NUMERO DE DOCUMENT

IND. B2

2162208219

SCHEMA DE PRINCIPLE

ET DE REGULATION

REVISION 4 SUR 37

NUMERO DE DOCUMENT

IND. B2

2162208219

SCHEMA DE PRINCIPLE

ET DE REGULATION

REVISION 4 SUR 37

NUMERO DE DOCUMENT

IND. B2

2162208219

SCHEMA DE PRINCIPLE

ET DE REGULATION

REVISION 4 SUR 37

NUMERO DE DOCUMENT

IND. B2

2162208219

SCHEMA DE PRINCIPLE

ET DE REGULATION

REVISION 4 SUR 37

NUMERO DE DOCUMENT

IND. B2

2162208219

SCHEMA DE PRINCIPLE

ET DE REGULATION

REVISION 4 SUR 37

NUMERO DE DOCUMENT

IND. B2

2162208219

SCHEMA DE PRINCIPLE

ET DE REGULATION

REVISION 4 SUR 37

NUMERO DE DOCUMENT

IND. B2

2162208219

SCHEMA DE PRINCIPLE

ET DE REGULATION

REVISION 4 SUR 37

NUMERO DE DOCUMENT

IND. B2

2162208219

SCHEMA DE PRINCIPLE

ET DE REGULATION

REVISION 4 SUR 37

NUMERO DE DOCUMENT

IND. B2

2162208219

SCHEMA DE PRINCIPLE

ET DE REGULATION

REVISION 4 SUR 37

NUMERO DE DOCUMENT

IND. B2

2162208219

SCHEMA DE PRINCIPLE

ET DE REGULATION

REVISION 4 SUR 37

NUMERO DE DOCUMENT

IND. B2

2162208219

SCHEMA DE PRINCIPLE

ET DE REGULATION

REVISION 4 SUR 37

NUMERO DE DOCUMENT

IND. B2

2162208219

SCHEMA DE PRINCIPLE

ET DE REGULATION

REVISION 4 SUR 37

NUMERO DE DOCUMENT

IND. B2

2162208219

SCHEMA DE PRINCIPLE

ET DE REGULATION

REVISION 4 SUR 37

NUMERO DE DOCUMENT

IND. B2

2162208219

CARTE_CPUBT

CE DOCUMENT EST LA PROPRIETE DE LA SOCIETE IL NE PEUT ETRE REPRODUIT NI COMMUNIQUE SANS AUTORISATION ECRIE

IND	REV	DATE	PREPARE	DESIGNATION	FORMAT
	A1	12/95		CI_CPUBT	A2
	A2	11/96		CARTE_CALCULATEUR	
	B2	04/97		SCHEMA DE PRINCIPLE	
	B3	04/97			
	B4	04/97			

SCHEMA DE PRINCIPLE		SCHEMA DE PRINCIPLE	
GENERALES D'EXECUTION	DATE	VERIFIE	PAR
ET DE TECHNIQUE	DATE	VERIFIE	PAR
FEUILLE 5	SR		
216222009	9		
NUMERO DE DOCUMENT		IND	

IND	REV	DATE	PREPARE	DESIGNATION	FORMAT
	A1	12/95		CI_CPUBT	A2
	A2	11/96		CARTE_CALCULATEUR	
	B2	04/97		SCHEMA DE PRINCIPLE	
	B3	04/97			
	B4	04/97			

DRAWING: 4 14:05:08 1995
 TITRE=CPUBT
 ABBRE=cpuBT

**VALABLE
POUR FABRICATION**

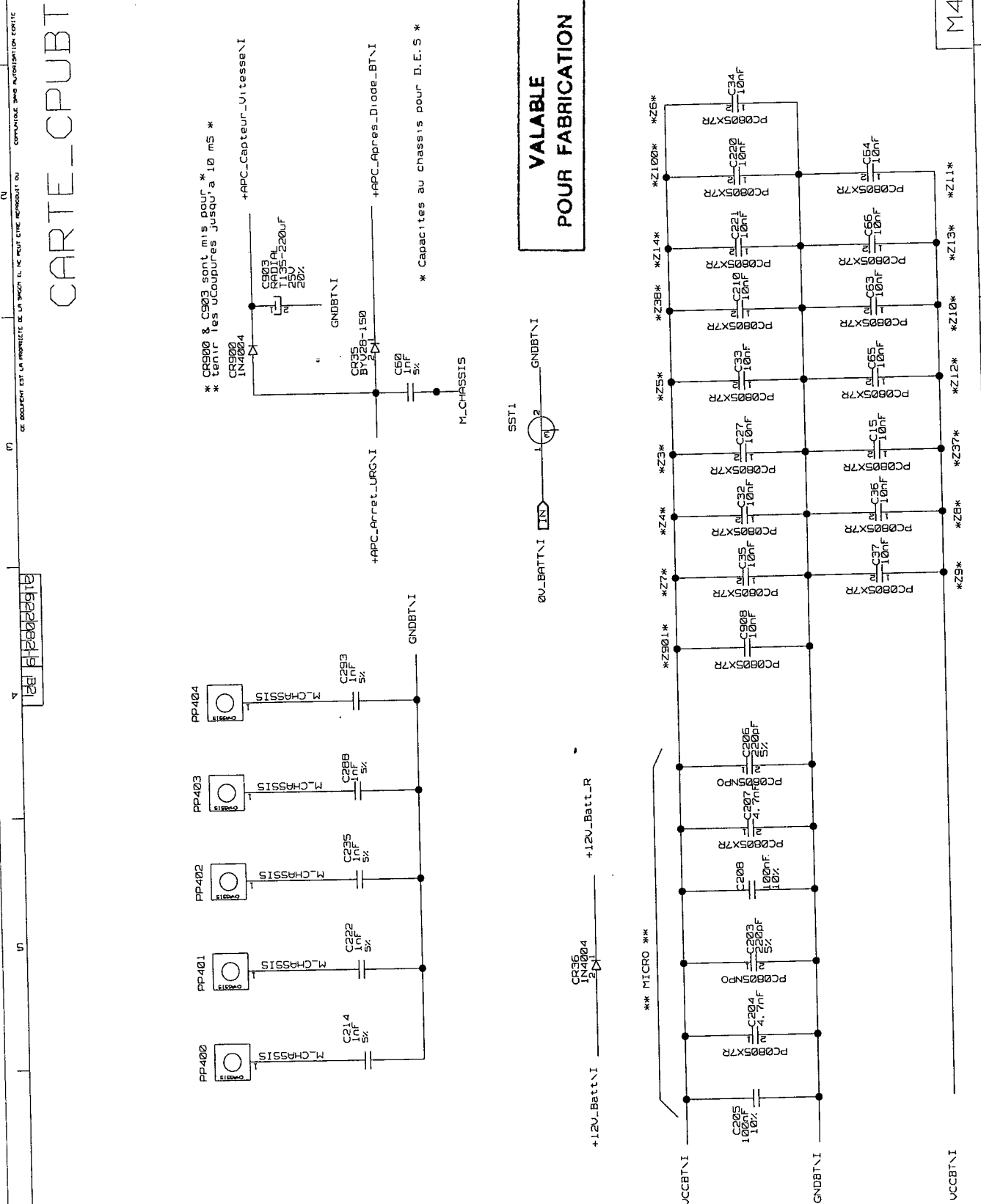

SCHEMA DE PRINCIPALE		SCHEMA DE PRINCIPALE	
ETABL	NOM	DATE	VERIFIE
PAR	RIBES	09/95	
DESIGNATION		CONTROLEUR_BT	
FORMAT		A2	
IND	DATE	B1	11/96
IND	DATE	B2	04/97
IND	DATE	B3	12/95
REVISIONS-CORRECTIONS			

SCHEMA DE PRINCIPALE		SCHEMA DE PRINCIPALE	
ETABL	NOM	DATE	VERIFIE
PAR	RIBES	09/95	
DESIGNATION		CONTROLEUR_BT	
FORMAT		A2	
IND	DATE	B1	11/96
IND	DATE	B2	04/97
IND	DATE	B3	12/95
REVISIONS-CORRECTIONS			

Mon Nov 4 14:32:52 1996

DRAWING:
CONTROLEUR_BT
CONTROL TEST

1

VALABLE
POUR FABRICATION

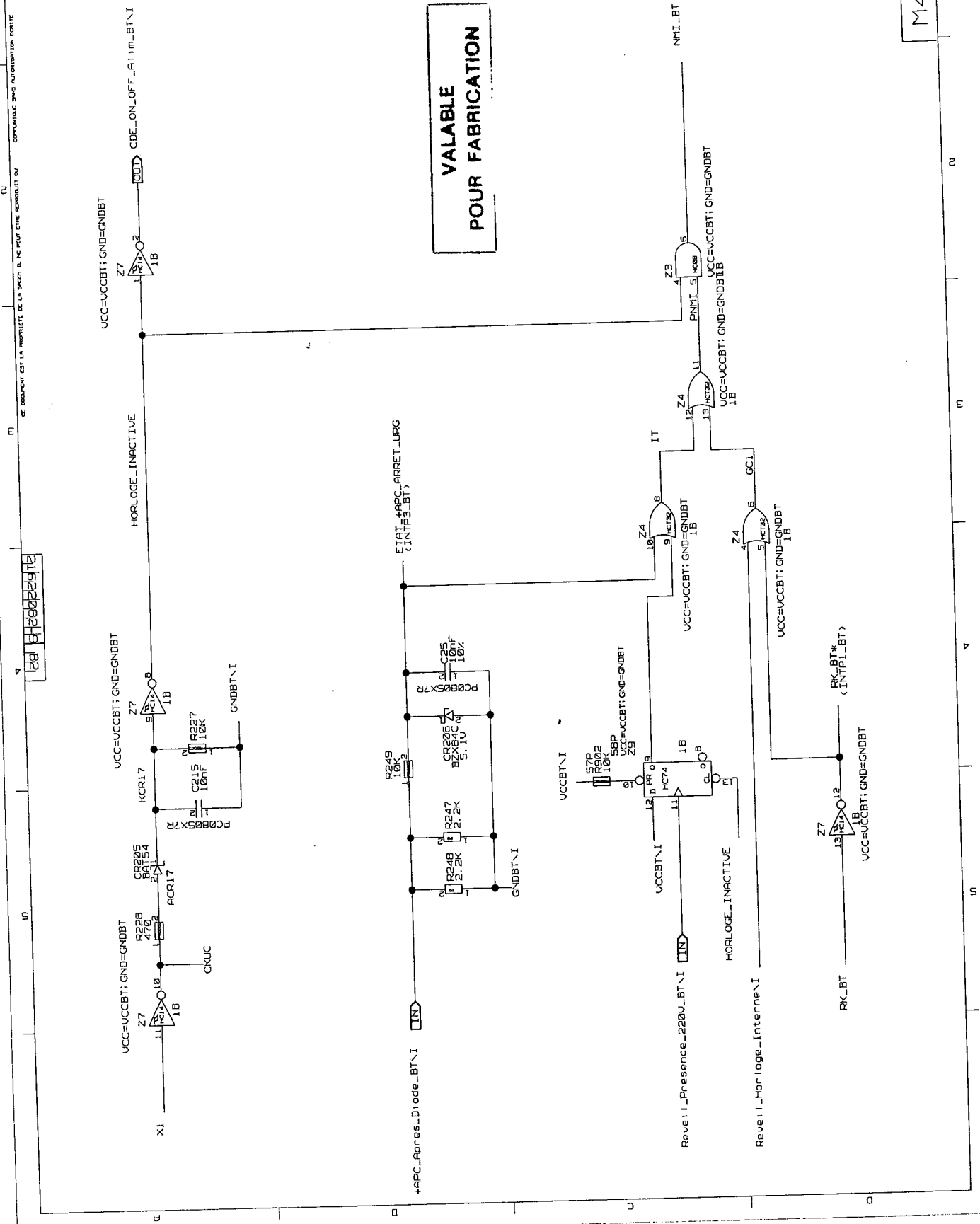

M49 SERIE TDS

DE DOCUMENT EST LA PROPRIETE DE LA SOCIETE IL NE PEUT ETRE REPRODUIT OU COMMUNIQUE SANS AUTORISATION ECRITE

SCHEMA DE PRINCIPALE		SCHEMA DE PRINCIPALE	
ETABL	VERIFIE	PAR	DATE
PER	RIBES	09/95	
DESIGNATION		CARTI-CALCULATUR	
FORMAT		A2	
REVISIONS		REVISIONS	
IND	DATE	A	12/95
B1	11/96	B2	04/97
B2	04/97		
REVISIONS		REVISIONS	
IND		IND	
NUMERO DE DOCUMENT		2162208219	
IND		B2	
FEUILLE		B SUR 37	
ET DE RECAVIOUE			
GENERALIS D'ELCTRICITE			
SOCIETE D'APPLICTIONS			

MON Nov 4 14:34:38 1996
 DRAWING: CONTROLEUR BT
 CONTROLLED C



CE DOCUMENT EST LA PROPRIETE DE LA SOCIETE. IL NE PEUT ETRE REPRODUIT OU COMMUNIQUE SANS AUTORISATION ECRIE

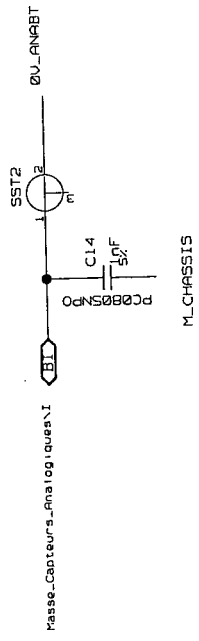
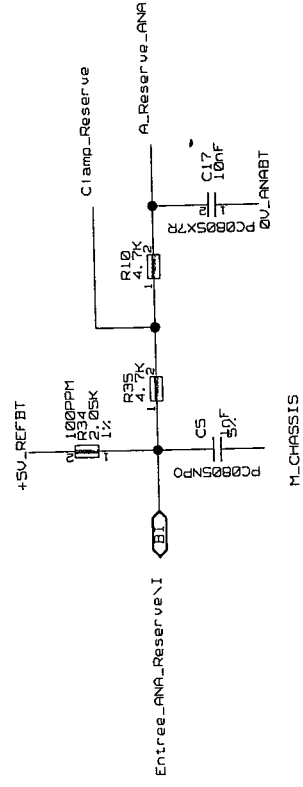
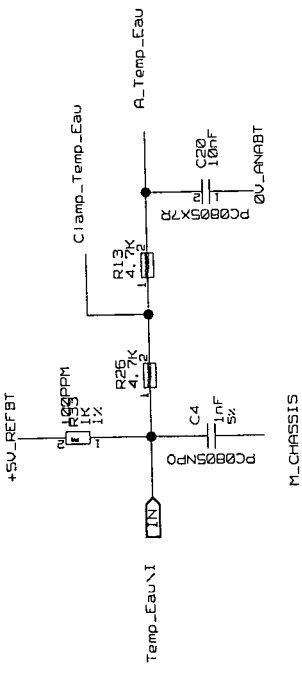
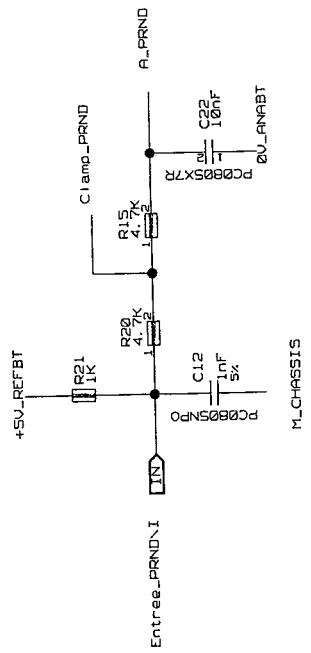
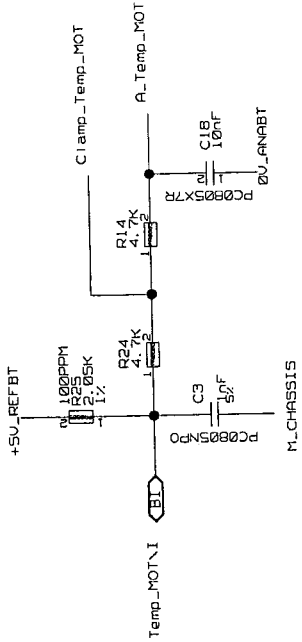

VALABLE
 POUR FABRICATION

1234567891011121314151617181920212223242526272829303132333435363738394041424344454647484950

U

M

N

U

C

D

D

B

C

D

U

V

W

X

Y

D

SCHEMA DE PRINCIPLE		SCHEMA DE PRINCIPLE	
GENERALITES D'ELECTRICITE	ET DE MECANIQUE	FEUILLE 9	SUR 37
CARTE-CALCULATEUR		CONTROLEUR_BT	
DESIGNATION		FORMAT R2	
TRABAI	RIBES	DATE	09/95
PER			
PRE			
REVISIONS			
B1	04/97		
B2	11/98		
D	12/98		

Med Nov 20 11:17:43 1996
 DRAWING: CONTROLEUR_BT controlled

4

VALABLE POUR FABRICATION

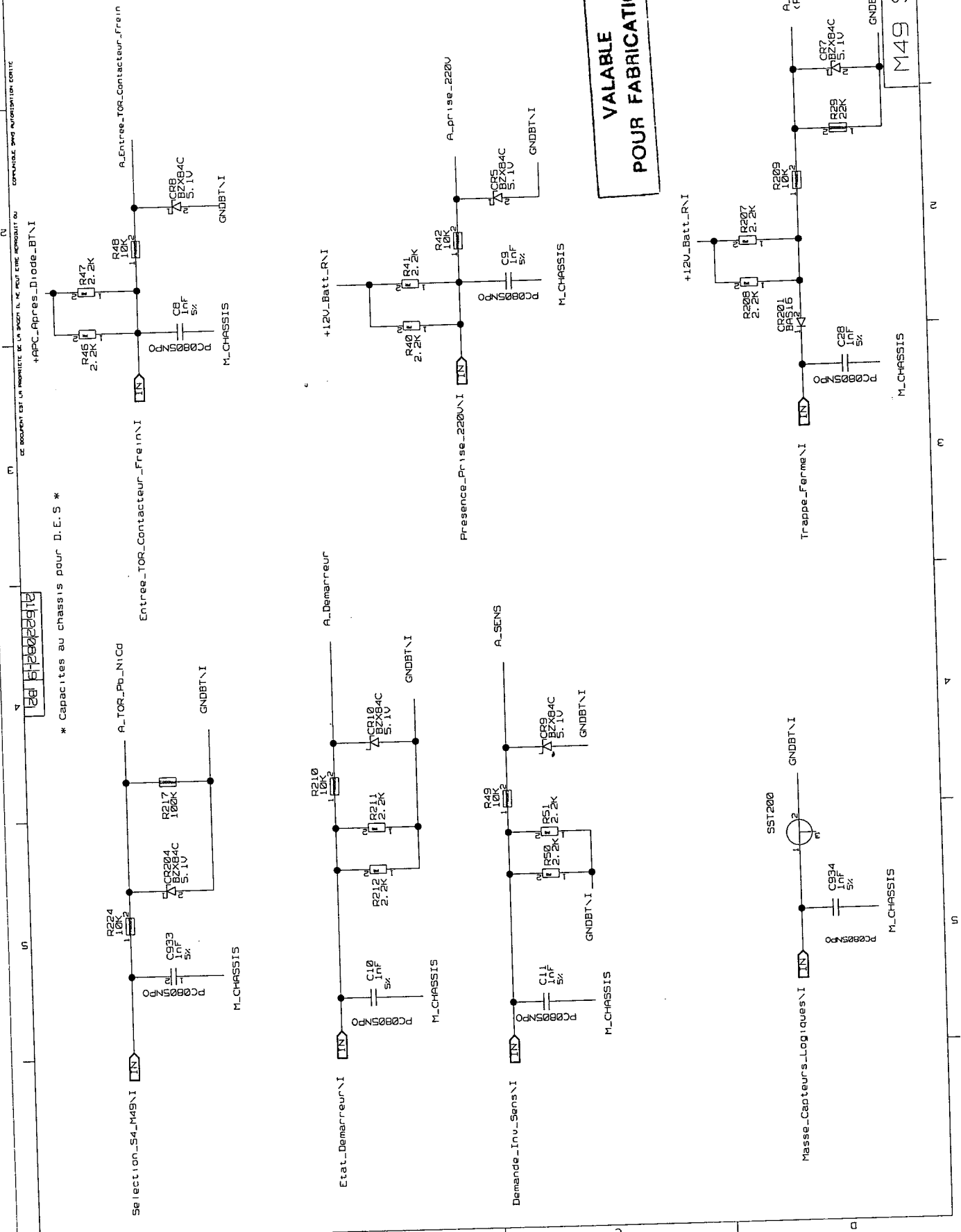

SC DOCUMENT EST LA PROPRIÉTÉ DE UN BRAS. IL NE POUV ÊTRE REPRODUIT OU COMMUNIQUÉ SANS AUTORISATION ÉCRITE

* Capacités au chassis pour D.E.S *

M49 SERIE TDS

5

Mon Nov 4 14:41:32 1996
 DRAWING: CONTROLUR_BT
 CONTROLUR_BT
 controlebt

SCHEMA DE PRINCIPES		SCHEMA DE PRINCIPES	
GENERALITES D'ELCTRICITE	ET DE MECANIQUE	REVISION 10	SR 37
SCHEMA DE PRINCIPES		CARTE_CALCULATEUR	
CONTROLUR_BT		CONTROLUR_BT	
NUMERO DE DOCUMENT		2162208219	
IND.		B2	

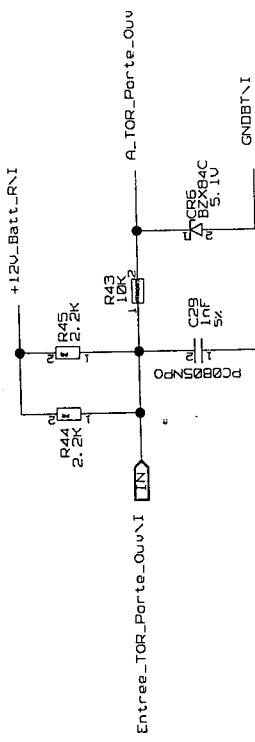

**VALABLE
 POUR FABRICATION**

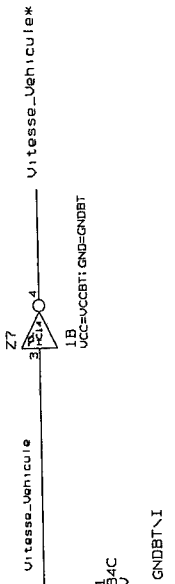
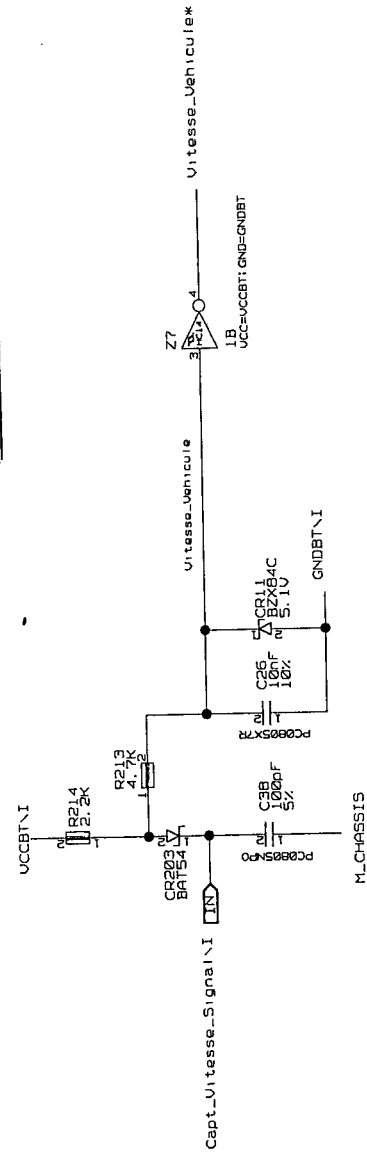
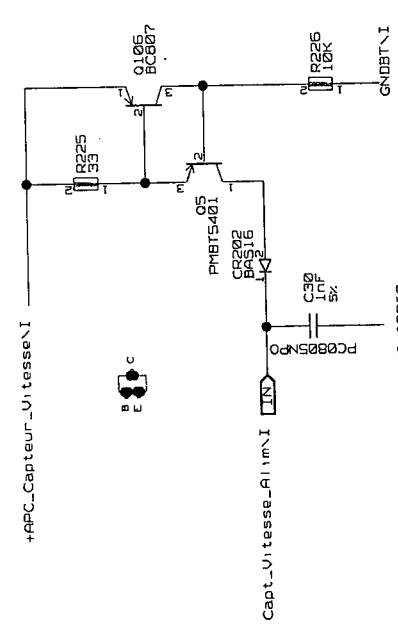

CE DOCUMENT EST LA PROPRIETE DE LA SOCIETE LE NOUS ETRE REPRODUIT OU COMMUNIQUE SANS AUTORISATION ECRIE

2162208219 B2

U

U

U

2

6

4

U

U

SCHEMA DE PRINCIPALE		SCHEMA DE PRINCIPALE	
GENERALITES D'APPLICATIONS	GENERALITES D'APPLICATIONS	GENERALITES D'APPLICATIONS	GENERALITES D'APPLICATIONS
ET DE MECANIQUE	ET DE MECANIQUE	ET DE MECANIQUE	ET DE MECANIQUE
REVUE	REVUE	REVUE	REVUE
13 SUR	13 SUR	13 SUR	13 SUR
37	37	37	37
CARTE-CALCULATEUR		CARTE-CALCULATEUR	
CONTROLEUR-BT		CONTROLEUR-BT	
N° 2162208219 B2		N° 2162208219 B2	
N° 2162208219 B2		N° 2162208219 B2	
IND.		IND.	

SCHEMA DE PRINCIPALE
 GENERALITES D'APPLICATIONS
 ET DE MECANIQUE
 REVUE 13 SUR 37
 CARTE-CALCULATEUR
 CONTROLEUR-BT
 N° 2162208219 B2
 N° 2162208219 B2
 IND.

**VALABLE
 POUR FABRICATION**

M49 SERIE TDS

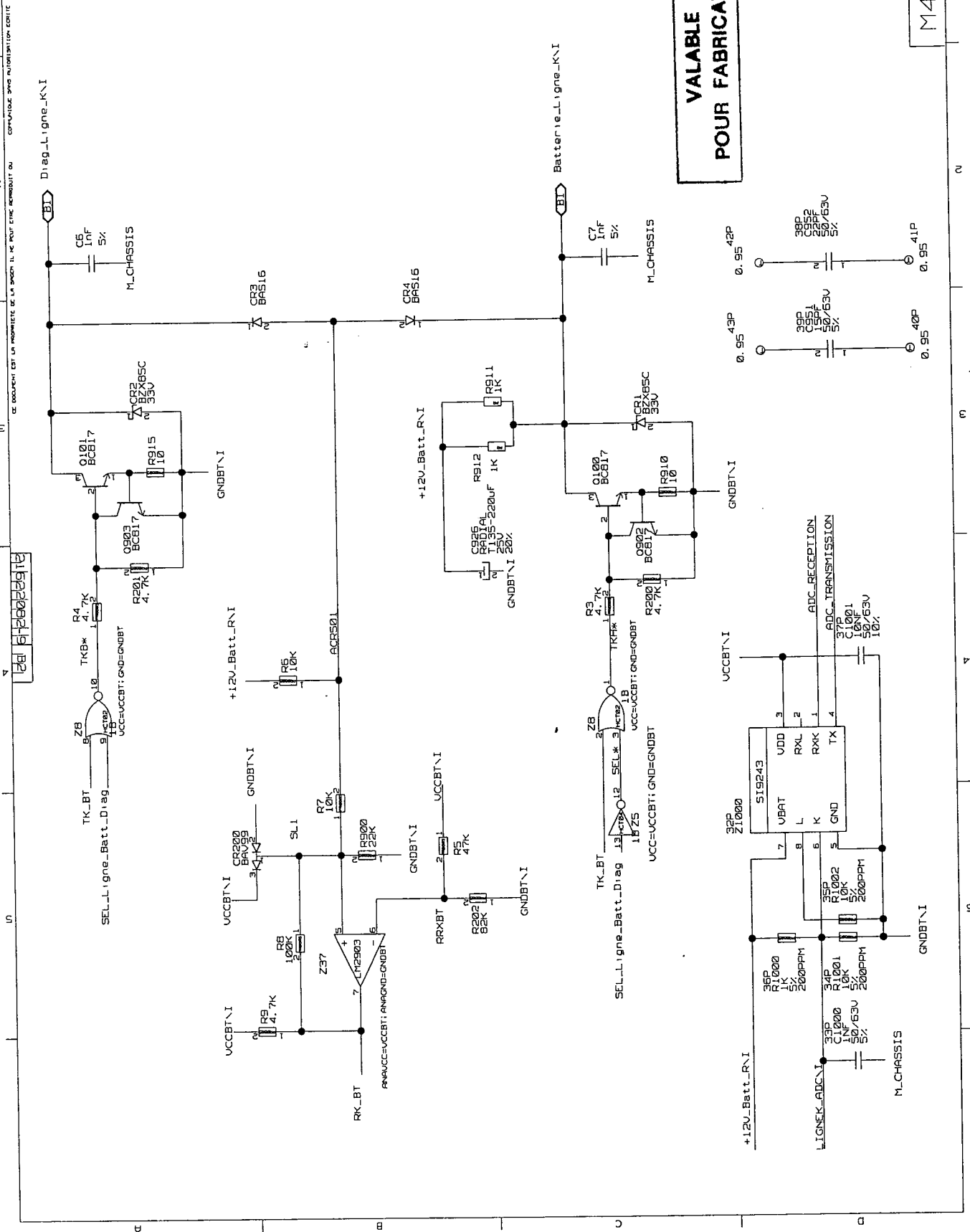

CE DOCUMENT EST LA PROPRIETE DE LA SOCIETE DE LA SUDON IL NE PEUT ETRE REPRODUIT OU COMMUNIQUE SANS AUTORISATION ECRITE

Mon Ppr 14 10:23:19 1997

M49 SERIE TDS

VALABLE
POUR FABRICATION

SCHEMA DE PRINCIPES		SCHEMA DE PRINCIPES	
GENERALITES D'ELECTRICITE	ET DE MECANIQUE	FEUILLE 14 SUR 37	2162220819 B2
CARTRE-CALCULATEUR		CONTROLLEUR-BT	
NOMBRE DE DOCUMENT		IND	
IND		IND	
DATE		DATE	
R1 11/96		R1 11/96	
R2 04/97		R2 04/97	
R3 12/95		R3 12/95	
REQUISITIONS-CORRECTIONS		REQUISITIONS-CORRECTIONS	
ETABLIS PAR	VERIFIE PAR	DATE	DATE
DESIGNATION		DESIGNATION	
FORMAT A2		FORMAT A2	

DRAWING:
CONTROLLEUR BT
CONTROLLED

Mon Nov 4 14:47:57 1996

CE DOCUMENT EST LA PROPRIETE DE LA SOCIETE IL NE PEUT ETRE REPRODUIT OU COMMUNIQUE SANS AUTORISATION ECRIE

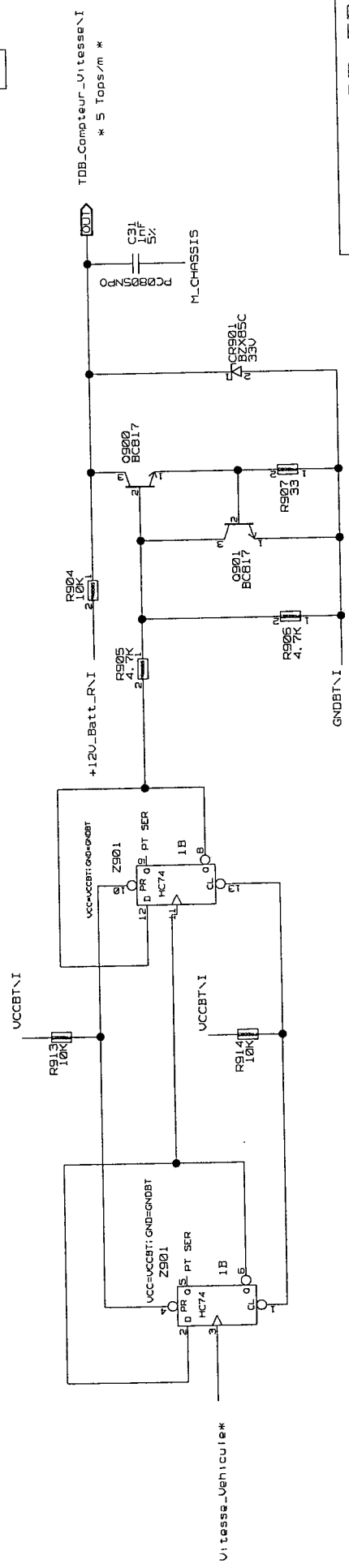
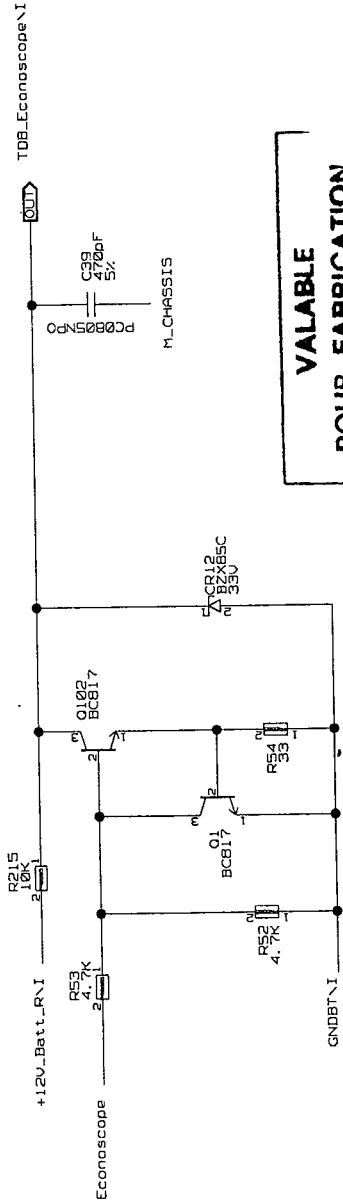
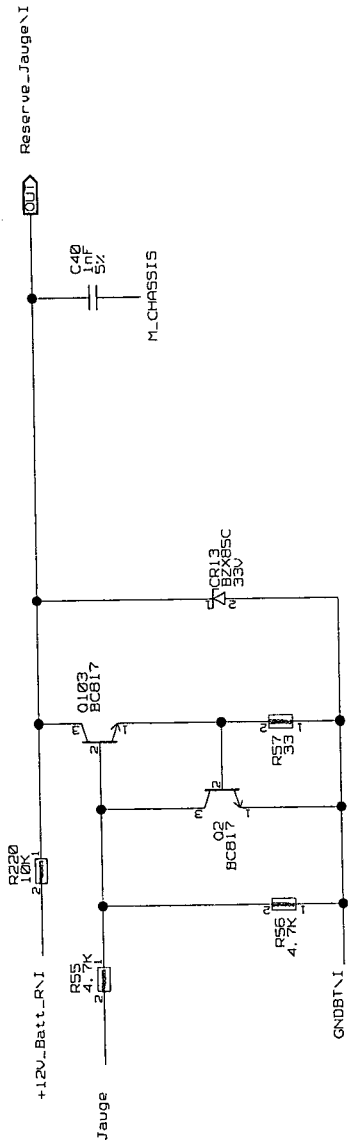

1 2 3 4 5 6 7 8 9 10 11 12 13 14 15 16 17 18 19 20 21 22 23 24 25 26 27 28 29 30 31 32 33 34 35 36 37 38 39 40 41 42 43 44 45 46 47 48 49 50 51 52 53 54 55 56 57 58 59 60 61 62 63 64 65 66 67 68 69 70 71 72 73 74 75 76 77 78 79 80 81 82 83 84 85 86 87 88 89 90 91 92 93 94 95 96 97 98 99 100

SCHEMA DE PRINCIPALE		SCHEMA DE PRINCIPALE	
DESIGNATION	CONTROLEUR BT	DESIGNATION	CONTROLEUR BT
FORMAT	R2	FORMAT	R2
IND	A1	IND	A1
DATE	12/95	DATE	12/95
IND	B2	IND	B2
DATE	11/96	DATE	11/96
IND	B2	IND	B2
DATE	04/97	DATE	04/97

SCHEMA DE PRINCIPALE		SCHEMA DE PRINCIPALE	
DESIGNATION	CONTROLEUR BT	DESIGNATION	CONTROLEUR BT
FORMAT	R2	FORMAT	R2
IND	A1	IND	A1
DATE	12/95	DATE	12/95
IND	B2	IND	B2
DATE	11/96	DATE	11/96
IND	B2	IND	B2
DATE	04/97	DATE	04/97

DRWING:
 CONTROLER BT
 CONTROLER BT

Mon Mar 24 15:09:57 1997

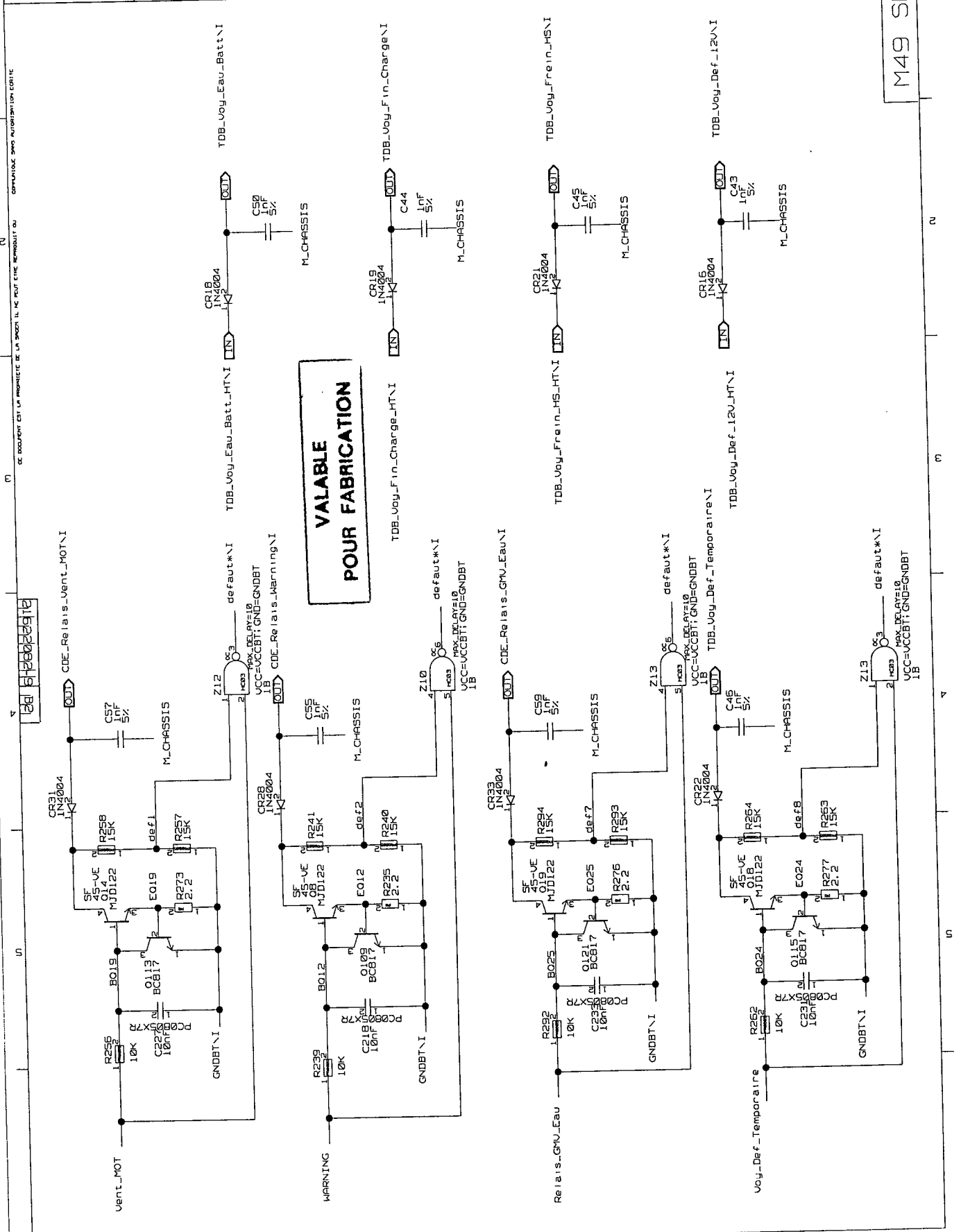

M49 SERIE TDS

CE DOCUMENT EST LA PROPRIETE DE LA SOCIETE IL NE PEUT ETRE REPRODUIT OU COMMUNIQUE SANS AUTORISATION ECRITE

SCHEMA DE PRINCIPALE

SCHEMA DE PRINCIPALE

SCHEMA DE PRINCIPALE

IND	A	12/95
IND	A1	11/96
IND	B2	04/97
IND	B2	09/95

IND	A	12/95
IND	A1	11/96
IND	B2	04/97
IND	B2	09/95

IND	A	12/95
IND	A1	11/96
IND	B2	04/97
IND	B2	09/95

IND	A	12/95
IND	A1	11/96
IND	B2	04/97
IND	B2	09/95

MON NOV 4 14:52:11 1996
 DRAWING:
 CONTROL_01 BT
 CONTROL_01 BT

13

CE DOCUMENT EST LA PROPRIETE DE LA SOCIETE IL NE PEUT ETRE REPRODUIT NI COMMUNIQUE SANS AUTORISATION ECRITE

12345678910

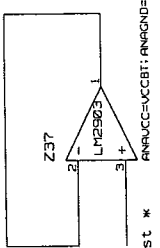

* pour le test *

**VALABLE
 POUR FABRICATION**

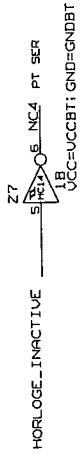
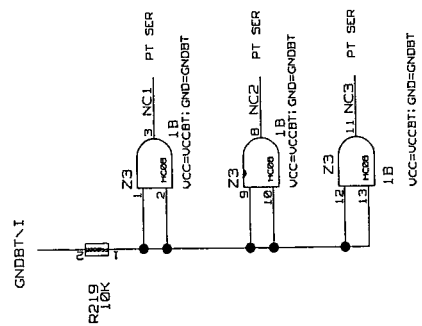

10 11 12 13 14 15 16 17 18 19 20 21 22 23 24 25 26 27 28 29 30 31 32 33 34 35 36 37 38 39 40 41 42 43 44 45 46 47 48 49 50 51 52 53 54 55 56 57 58 59 60 61 62 63 64 65 66 67 68 69 70 71 72 73 74 75 76 77 78 79 80 81 82 83 84 85 86 87 88 89 90 91 92 93 94 95 96 97 98 99 100

1

DRAWING: P3BBREV=opto
 TITLE=OPTO
 Thu Nov 7 09:06:55 1996

IND	DATE	REVISIONS-CORRECTIONS
B2	04/97	
A1	11/96	
A	12/95	
DESIGNATION		
FORMAT A2		
SCHEMA DE PRINCIPLE		
CARTE-CALCULATRICE		
CLIAISON-OPTO		
NUMERO DE DOCUMENT		
IND. 21622208219 B2		
FEUILLE 19 sur 37		
SOCIETE D'APPLICATIONS		
GERANCE D'EXECUTION		
ET DE RECAVAGE		
TABLE	NON	DATE
VERIFIE	NON	DATE
PAR	RIBES	09/95

SCHEMA DE PRINCIPLE

COMPAGNIE DES AUTOMATISME CONTIC

CE DOCUMENT EST LA PROPRIETE DE LA SOCIETE. IL NE PEUT ETRE REPRODUIT OU

REPRODUIRE

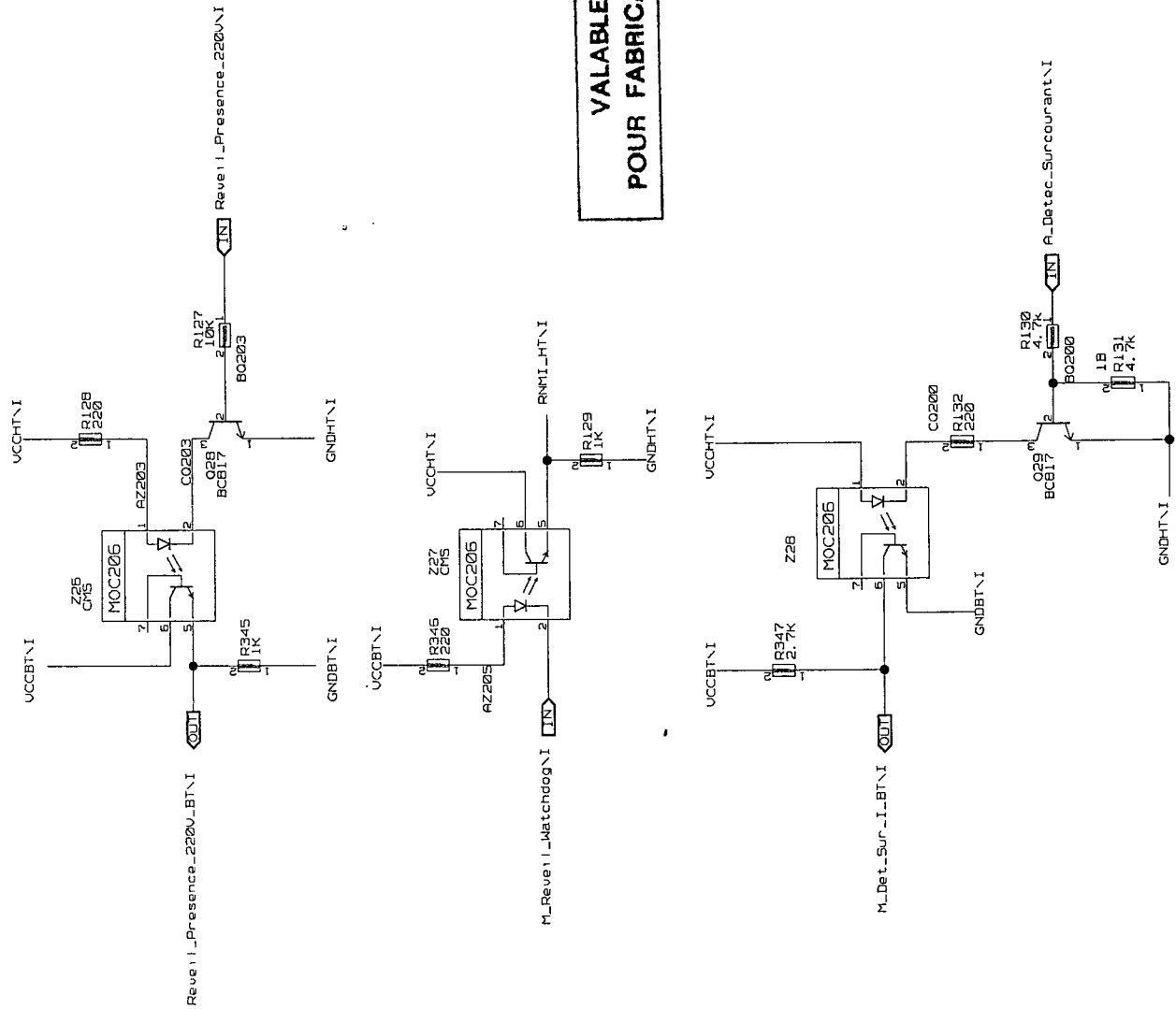

VALABLE
 POUR FABRICATION

CE DOCUMENT EST LA PROPRIETE DE UN GROUP IL NE PEUT ETRE REPRODIT OU COMMUNIQUE SANS AUTORISATION ECRIE

CARTE_CPUHT

SCHEMA DE PRINCIPLE
 GENERALITES D'EXPLICATIONS
 ET DE RECONSTITUTION

FEUILLE	23	SUR	37
NUMERO DE DOCUMENT	216220829		
IND	B2		

SCHEMA DE PRINCIPLE	DATE	09/95	VERIFIE PAR	
DESIGNATION	CI-CPUHT			
FORMAT	A2			

IND	A	12/95
IND	A1	11/96
IND	B2	04/97

DRAWING: TITLE=CPUHT
 ABBREV=cpunt

3

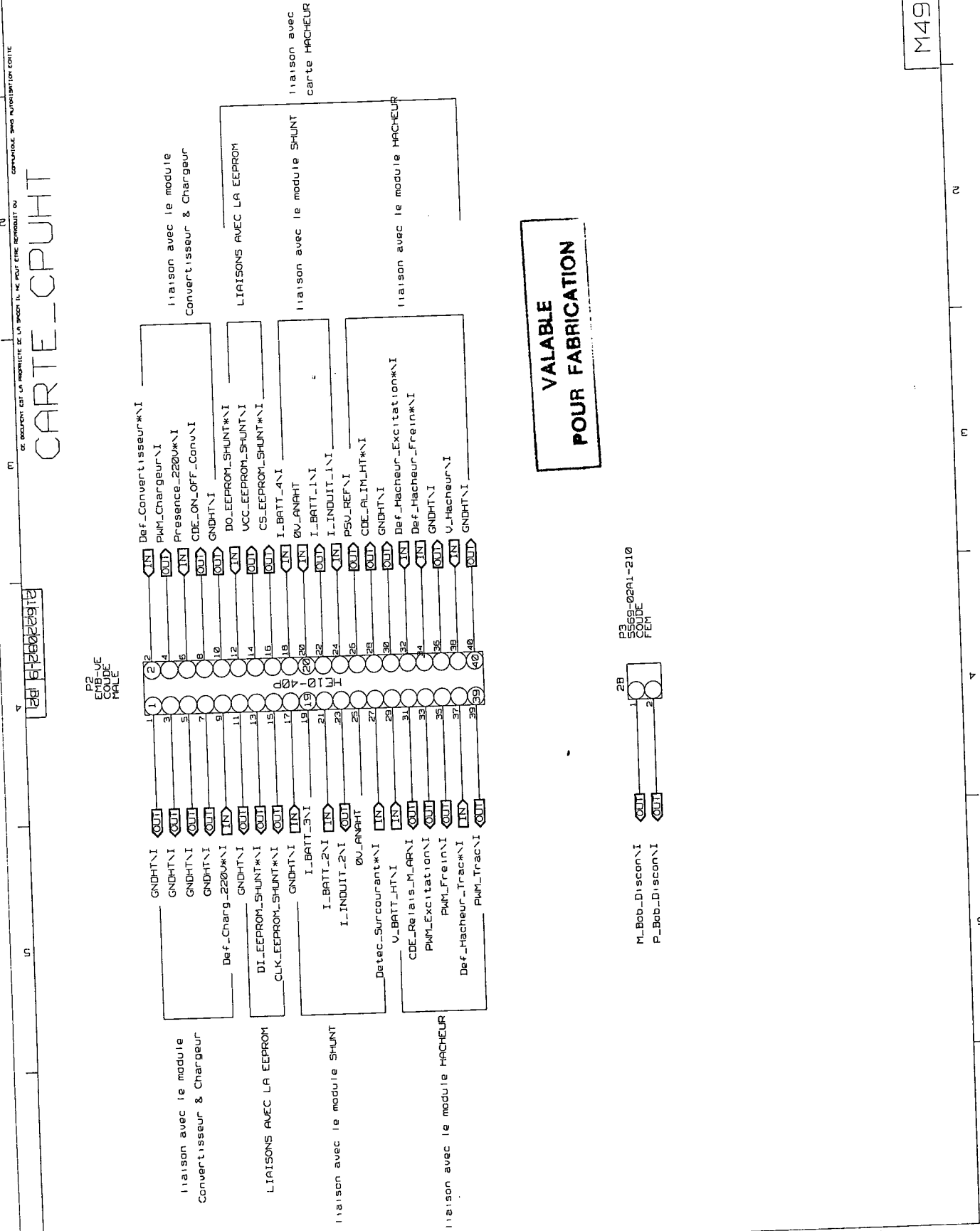

VALABLE POUR FABRICATION

M49 SERIE TDS

P3 69-02A1-210
 CODE FEM



M_Bob_DiscovNI
 P_Bob_DiscovNI



CARTE_CPUHT

** composants BT non utilises sur carte HT **

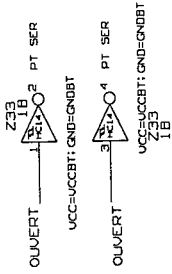
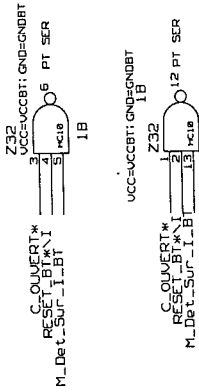

**VALABLE
POUR FABRICATION**

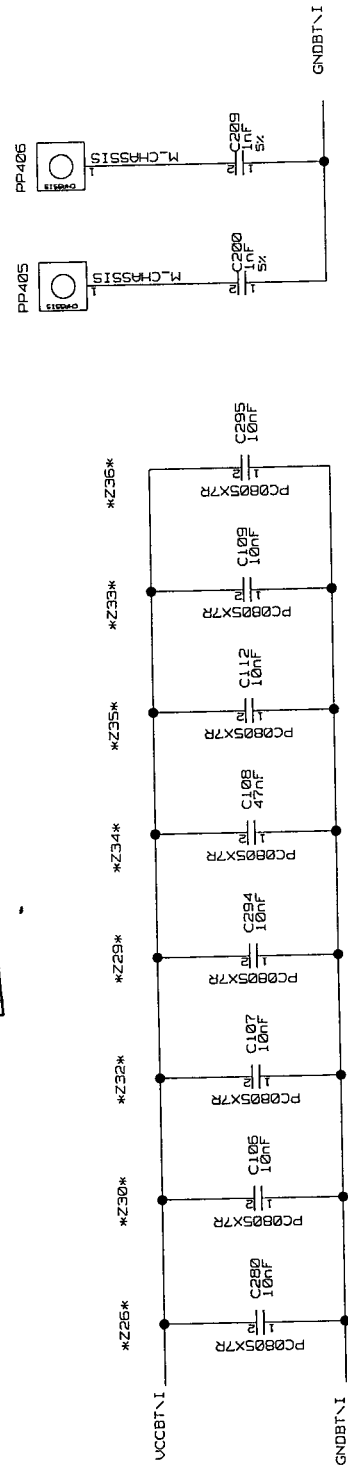

SCHEMA DE PRINCIPLE		SCHEMA DE PRINCIPLE	
ENTR. NOM	DATE	DATE	DATE
ENTR. RIBES	DATE	DATE	DATE
REVISIONS-CORRECTIONS		REVISIONS-CORRECTIONS	
IND	DATE	IND	DATE
A1	12/95	A	12/95
A1	11/96	A1	11/96
B2	04/97	B2	04/97
DESIGNATION		DESIGNATION	
CI-CPUHT		CI-CPUHT	
CARTE CALCULATEUR		CARTE CALCULATEUR	
REVISIONS-CORRECTIONS		REVISIONS-CORRECTIONS	
IND	DATE	IND	DATE
B2	09/95	B2	09/95
SCHEMA DE PRINCIPLE		SCHEMA DE PRINCIPLE	
REVISIONS-CORRECTIONS		REVISIONS-CORRECTIONS	
IND	DATE	IND	DATE
B2	09/95	B2	09/95
DESIGNATION		DESIGNATION	
CI-CPUHT		CI-CPUHT	
CARTE CALCULATEUR		CARTE CALCULATEUR	
REVISIONS-CORRECTIONS		REVISIONS-CORRECTIONS	
IND	DATE	IND	DATE
B2	09/95	B2	09/95

DRAWING: 4
LIBRE-COUP
ABBREV-COUP
Mon Nov 4 13:54:15 1996

CE DOCUMENT EST LA PROPRIETE DE LA SOCIETE IL NE PEUT ETRE REPRODUIT OU COMMUNIQUE SANS AUTORISATION ECRIE

1 2 3 4 5 6 7 8 9 10 11 12 13 14 15 16 17 18 19 20 21 22 23 24 25 26 27 28 29 30 31 32 33 34 35 36 37 38 39 40 41 42 43 44 45 46 47 48 49 50 51 52 53 54 55 56 57 58 59 60 61 62 63 64 65 66 67 68 69 70 71 72 73 74 75 76 77 78 79 80 81 82 83 84 85 86 87 88 89 90 91 92 93 94 95 96 97 98 99 100

1

1

M49 SERIE TDS

IND	D1	11/96
IND	D2	12/95
IND	D3	12/95
IND	D4	12/95
IND	D5	12/95
IND	D6	12/95
IND	D7	12/95
IND	D8	12/95
IND	D9	12/95
IND	D10	12/95
IND	D11	12/95
IND	D12	12/95
IND	D13	12/95
IND	D14	12/95
IND	D15	12/95
IND	D16	12/95
IND	D17	12/95
IND	D18	12/95
IND	D19	12/95
IND	D20	12/95
IND	D21	12/95
IND	D22	12/95
IND	D23	12/95
IND	D24	12/95
IND	D25	12/95
IND	D26	12/95
IND	D27	12/95
IND	D28	12/95
IND	D29	12/95
IND	D30	12/95
IND	D31	12/95
IND	D32	12/95
IND	D33	12/95
IND	D34	12/95
IND	D35	12/95
IND	D36	12/95
IND	D37	12/95
IND	D38	12/95
IND	D39	12/95
IND	D40	12/95
IND	D41	12/95
IND	D42	12/95
IND	D43	12/95
IND	D44	12/95
IND	D45	12/95
IND	D46	12/95
IND	D47	12/95
IND	D48	12/95
IND	D49	12/95
IND	D50	12/95
IND	D51	12/95
IND	D52	12/95
IND	D53	12/95
IND	D54	12/95
IND	D55	12/95
IND	D56	12/95
IND	D57	12/95
IND	D58	12/95
IND	D59	12/95
IND	D60	12/95
IND	D61	12/95
IND	D62	12/95
IND	D63	12/95
IND	D64	12/95
IND	D65	12/95
IND	D66	12/95
IND	D67	12/95
IND	D68	12/95
IND	D69	12/95
IND	D70	12/95
IND	D71	12/95
IND	D72	12/95
IND	D73	12/95
IND	D74	12/95
IND	D75	12/95
IND	D76	12/95
IND	D77	12/95
IND	D78	12/95
IND	D79	12/95
IND	D80	12/95
IND	D81	12/95
IND	D82	12/95
IND	D83	12/95
IND	D84	12/95
IND	D85	12/95
IND	D86	12/95
IND	D87	12/95
IND	D88	12/95
IND	D89	12/95
IND	D90	12/95
IND	D91	12/95
IND	D92	12/95
IND	D93	12/95
IND	D94	12/95
IND	D95	12/95
IND	D96	12/95
IND	D97	12/95
IND	D98	12/95
IND	D99	12/95
IND	D100	12/95

SCHEMA DE PRINCIPALE	SCHEMA DE PRINCIPALE
GENERALITES D ELECTRICITE	GENERALITES D ELECTRICITE
ET DE RECONTOUR	ET DE RECONTOUR
FEUILLE 26	FEUILLE 26
sur 37	sur 37
NUMERO DE DOCUMENT	NUMERO DE DOCUMENT
216222022	216222022
IND. 1	IND. 1

SCHEMA DE PRINCIPALE
 GENERALITES D ELECTRICITE
 ET DE RECONTOUR
 FEUILLE 26 sur 37
 NUMERO DE DOCUMENT 216222022
 IND. 1

IND	D1	11/96
IND	D2	12/95
IND	D3	12/95
IND	D4	12/95
IND	D5	12/95
IND	D6	12/95
IND	D7	12/95
IND	D8	12/95
IND	D9	12/95
IND	D10	12/95
IND	D11	12/95
IND	D12	12/95
IND	D13	12/95
IND	D14	12/95
IND	D15	12/95
IND	D16	12/95
IND	D17	12/95
IND	D18	12/95
IND	D19	12/95
IND	D20	12/95
IND	D21	12/95
IND	D22	12/95
IND	D23	12/95
IND	D24	12/95
IND	D25	12/95
IND	D26	12/95
IND	D27	12/95
IND	D28	12/95
IND	D29	12/95
IND	D30	12/95
IND	D31	12/95
IND	D32	12/95
IND	D33	12/95
IND	D34	12/95
IND	D35	12/95
IND	D36	12/95
IND	D37	12/95
IND	D38	12/95
IND	D39	12/95
IND	D40	12/95
IND	D41	12/95
IND	D42	12/95
IND	D43	12/95
IND	D44	12/95
IND	D45	12/95
IND	D46	12/95
IND	D47	12/95
IND	D48	12/95
IND	D49	12/95
IND	D50	12/95
IND	D51	12/95
IND	D52	12/95
IND	D53	12/95
IND	D54	12/95
IND	D55	12/95
IND	D56	12/95
IND	D57	12/95
IND	D58	12/95
IND	D59	12/95
IND	D60	12/95
IND	D61	12/95
IND	D62	12/95
IND	D63	12/95
IND	D64	12/95
IND	D65	12/95
IND	D66	12/95
IND	D67	12/95
IND	D68	12/95
IND	D69	12/95
IND	D70	12/95
IND	D71	12/95
IND	D72	12/95
IND	D73	12/95
IND	D74	12/95
IND	D75	12/95
IND	D76	12/95
IND	D77	12/95
IND	D78	12/95
IND	D79	12/95
IND	D80	12/95
IND	D81	12/95
IND	D82	12/95
IND	D83	12/95
IND	D84	12/95
IND	D85	12/95
IND	D86	12/95
IND	D87	12/95
IND	D88	12/95
IND	D89	12/95
IND	D90	12/95
IND	D91	12/95
IND	D92	12/95
IND	D93	12/95
IND	D94	12/95
IND	D95	12/95
IND	D96	12/95
IND	D97	12/95
IND	D98	12/95
IND	D99	12/95
IND	D100	12/95

EBT HT

* Capacites C927 a C930 pour D.E.S *

VALABLE POUR FABRICATION

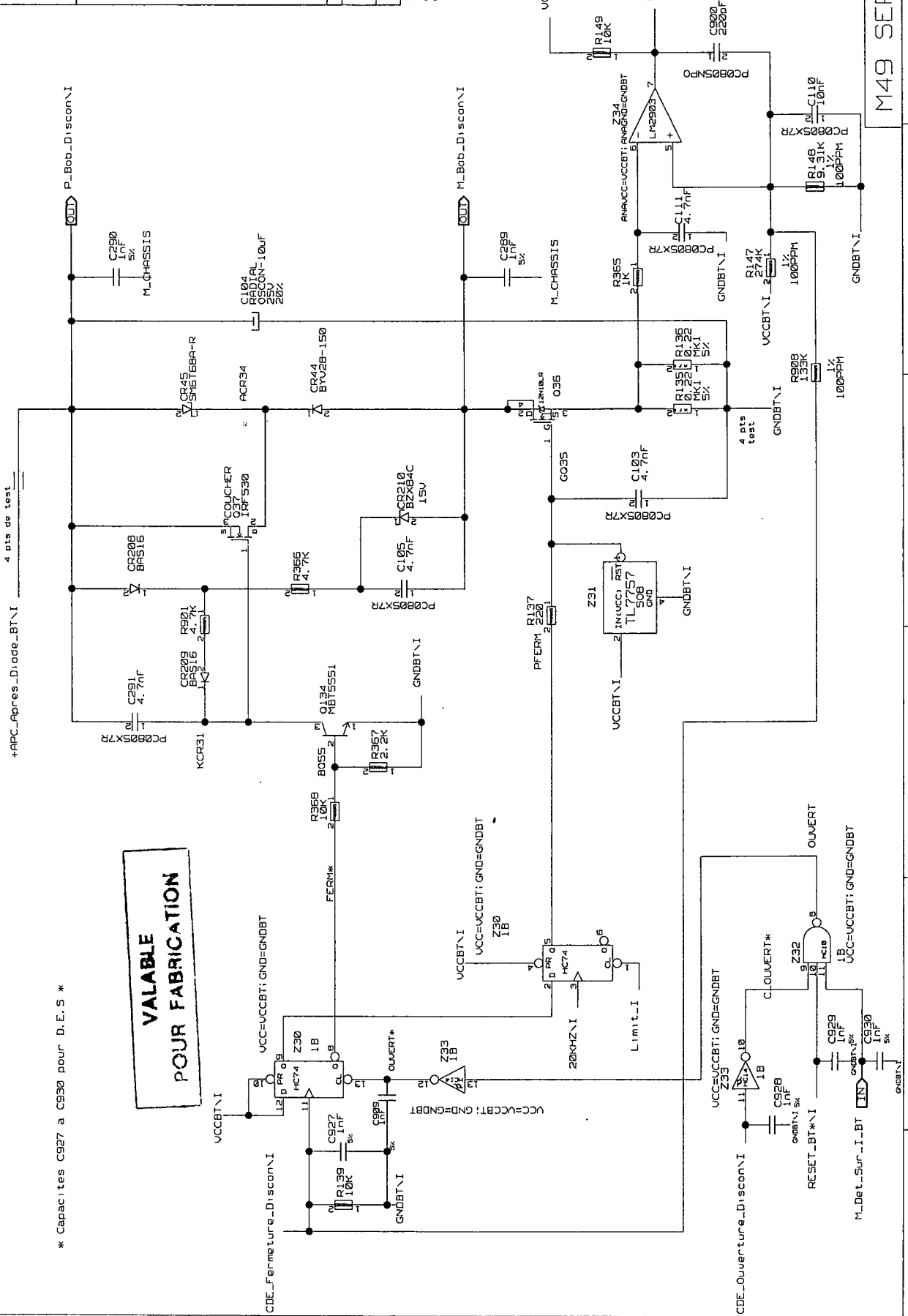

M49 SERIE TDS

MON Nov 4 14:07:18 1996

DRAWING: CONTROLEUR-HT

CONTROL

IND	A	12/95	FORMAT	A2
REV	B1	11/96	DESIGNATION	CONTROLEUR-HT
REV	B2	04/97	SCHEMA DE PRINCIPLE	SCHEMA DE PRINCIPLE
REV	B3	09/95	VERIFIE	PER
REV	B4	09/95	DATE	NOM
REV	B5	09/95	DATE	NOM
REV	B6	09/95	DATE	NOM
REV	B7	09/95	DATE	NOM
REV	B8	09/95	DATE	NOM
REV	B9	09/95	DATE	NOM
REV	B10	09/95	DATE	NOM
REV	B11	09/95	DATE	NOM
REV	B12	09/95	DATE	NOM
REV	B13	09/95	DATE	NOM
REV	B14	09/95	DATE	NOM
REV	B15	09/95	DATE	NOM
REV	B16	09/95	DATE	NOM
REV	B17	09/95	DATE	NOM
REV	B18	09/95	DATE	NOM
REV	B19	09/95	DATE	NOM
REV	B20	09/95	DATE	NOM
REV	B21	09/95	DATE	NOM
REV	B22	09/95	DATE	NOM
REV	B23	09/95	DATE	NOM
REV	B24	09/95	DATE	NOM
REV	B25	09/95	DATE	NOM
REV	B26	09/95	DATE	NOM
REV	B27	09/95	DATE	NOM
REV	B28	09/95	DATE	NOM
REV	B29	09/95	DATE	NOM
REV	B30	09/95	DATE	NOM
REV	B31	09/95	DATE	NOM
REV	B32	09/95	DATE	NOM
REV	B33	09/95	DATE	NOM
REV	B34	09/95	DATE	NOM
REV	B35	09/95	DATE	NOM
REV	B36	09/95	DATE	NOM
REV	B37	09/95	DATE	NOM
REV	B38	09/95	DATE	NOM
REV	B39	09/95	DATE	NOM
REV	B40	09/95	DATE	NOM
REV	B41	09/95	DATE	NOM
REV	B42	09/95	DATE	NOM
REV	B43	09/95	DATE	NOM
REV	B44	09/95	DATE	NOM
REV	B45	09/95	DATE	NOM
REV	B46	09/95	DATE	NOM
REV	B47	09/95	DATE	NOM
REV	B48	09/95	DATE	NOM
REV	B49	09/95	DATE	NOM
REV	B50	09/95	DATE	NOM
REV	B51	09/95	DATE	NOM
REV	B52	09/95	DATE	NOM
REV	B53	09/95	DATE	NOM
REV	B54	09/95	DATE	NOM
REV	B55	09/95	DATE	NOM
REV	B56	09/95	DATE	NOM
REV	B57	09/95	DATE	NOM
REV	B58	09/95	DATE	NOM
REV	B59	09/95	DATE	NOM
REV	B60	09/95	DATE	NOM
REV	B61	09/95	DATE	NOM
REV	B62	09/95	DATE	NOM
REV	B63	09/95	DATE	NOM
REV	B64	09/95	DATE	NOM
REV	B65	09/95	DATE	NOM
REV	B66	09/95	DATE	NOM
REV	B67	09/95	DATE	NOM
REV	B68	09/95	DATE	NOM
REV	B69	09/95	DATE	NOM
REV	B70	09/95	DATE	NOM
REV	B71	09/95	DATE	NOM
REV	B72	09/95	DATE	NOM
REV	B73	09/95	DATE	NOM
REV	B74	09/95	DATE	NOM
REV	B75	09/95	DATE	NOM
REV	B76	09/95	DATE	NOM
REV	B77	09/95	DATE	NOM
REV	B78	09/95	DATE	NOM
REV	B79	09/95	DATE	NOM
REV	B80	09/95	DATE	NOM
REV	B81	09/95	DATE	NOM
REV	B82	09/95	DATE	NOM
REV	B83	09/95	DATE	NOM
REV	B84	09/95	DATE	NOM
REV	B85	09/95	DATE	NOM
REV	B86	09/95	DATE	NOM
REV	B87	09/95	DATE	NOM
REV	B88	09/95	DATE	NOM
REV	B89	09/95	DATE	NOM
REV	B90	09/95	DATE	NOM
REV	B91	09/95	DATE	NOM
REV	B92	09/95	DATE	NOM
REV	B93	09/95	DATE	NOM
REV	B94	09/95	DATE	NOM
REV	B95	09/95	DATE	NOM
REV	B96	09/95	DATE	NOM
REV	B97	09/95	DATE	NOM
REV	B98	09/95	DATE	NOM
REV	B99	09/95	DATE	NOM
REV	B100	09/95	DATE	NOM

VALABLE
POUR FABRICATION

CE DOCUMENT EST LA PROPRIETE DE LA SOCIETE IL NE PEUT ETRE REPRODUIT OU COMMUNIQUE SANS AUTORISATION ECRIE

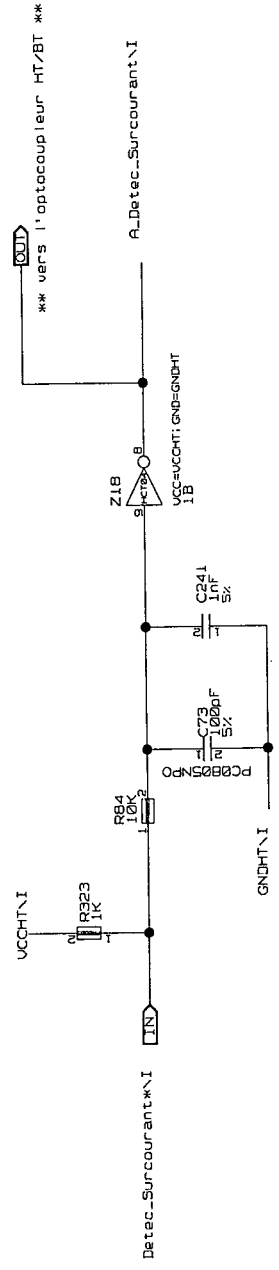
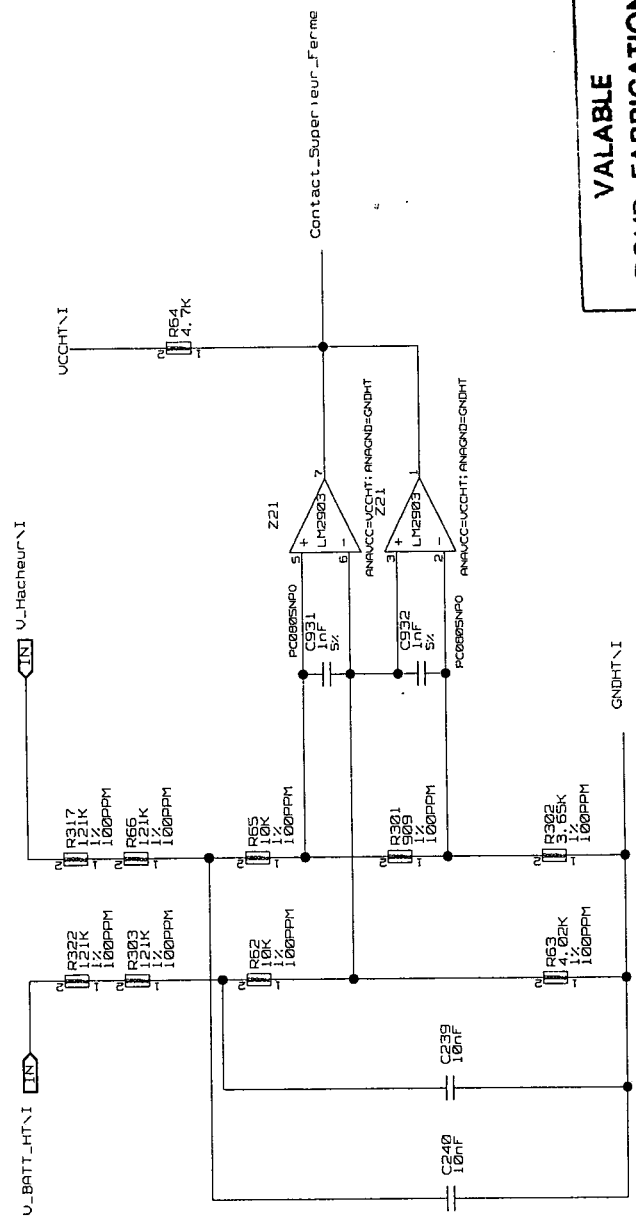

123456789101112131415161718192021222324252627282930313233343536373839404142434445464748495051525354555657585960616263646566676869707172737475767778798081828384858687888990919293949596979899100

1 2 3 4 5

SCHEMA DE PRINCIPALE		SCHEMA DE PRINCIPALE	
GENERALES D'ELLECTRICITE	DATE	VERIFIE	PAR
CT DE RECAVATION	09/95		
FEUILLE	28	SUR 37	
NUMERO DE DOCUMENT	216220849 B2		
IND	B2		

SCHEMA DE PRINCIPALE		SCHEMA DE PRINCIPALE	
GENERALES D'ELLECTRICITE	DATE	VERIFIE	PAR
CT DE RECAVATION	09/95		
FEUILLE	28	SUR 37	
NUMERO DE DOCUMENT	216220849 B2		
IND	B2		

SCHEMA DE PRINCIPALE		SCHEMA DE PRINCIPALE	
GENERALES D'ELLECTRICITE	DATE	VERIFIE	PAR
CT DE RECAVATION	09/95		
FEUILLE	28	SUR 37	
NUMERO DE DOCUMENT	216220849 B2		
IND	B2		

SCHEMA DE PRINCIPALE		SCHEMA DE PRINCIPALE	
GENERALES D'ELLECTRICITE	DATE	VERIFIE	PAR
CT DE RECAVATION	09/95		
FEUILLE	28	SUR 37	
NUMERO DE DOCUMENT	216220849 B2		
IND	B2		

SCHEMA DE PRINCIPALE		SCHEMA DE PRINCIPALE	
GENERALES D'ELLECTRICITE	DATE	VERIFIE	PAR
CT DE RECAVATION	09/95		
FEUILLE	28	SUR 37	
NUMERO DE DOCUMENT	216220849 B2		
IND	B2		

MON NOV 4 14:08:03 1995

DRAWING:
CONTROLEUR HT
CONTROLER

2

DE DOCUMENT EST LA PROPRIETE DE LA SOCIETE DE LA MACHIN IL NE PEUT ETRE REPRODUIT OU COMMUNIQUE SANS AUTORISATION ECRIE

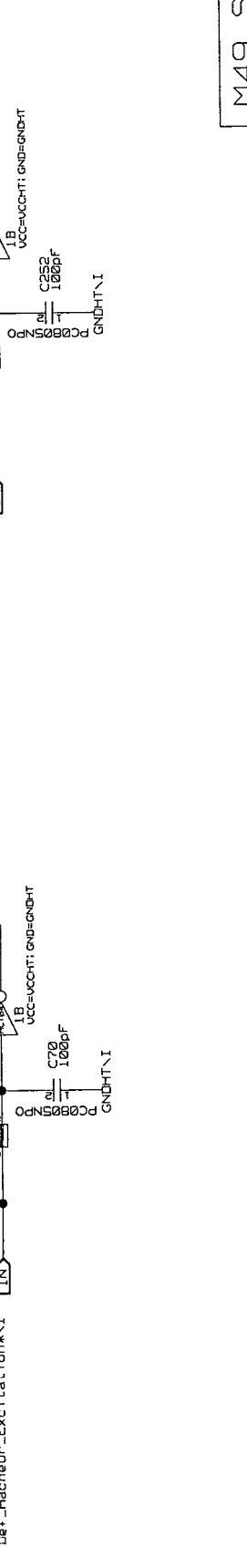
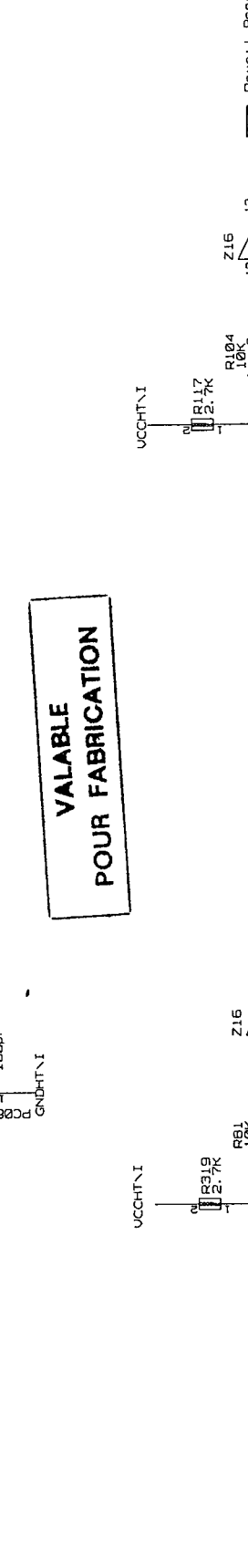
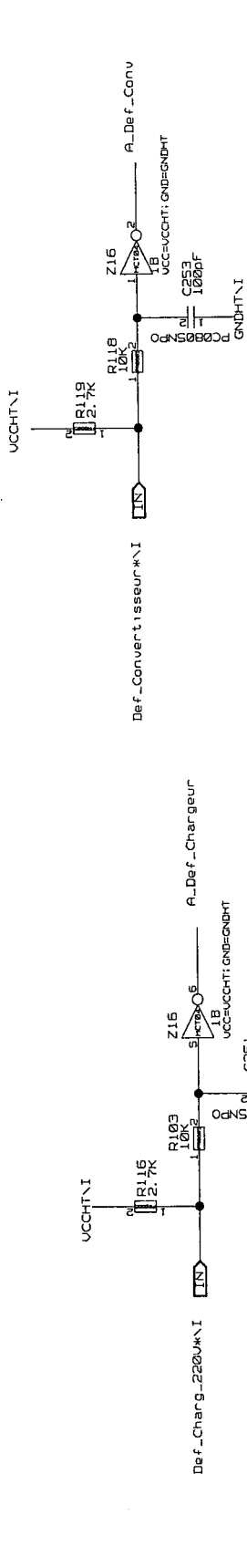
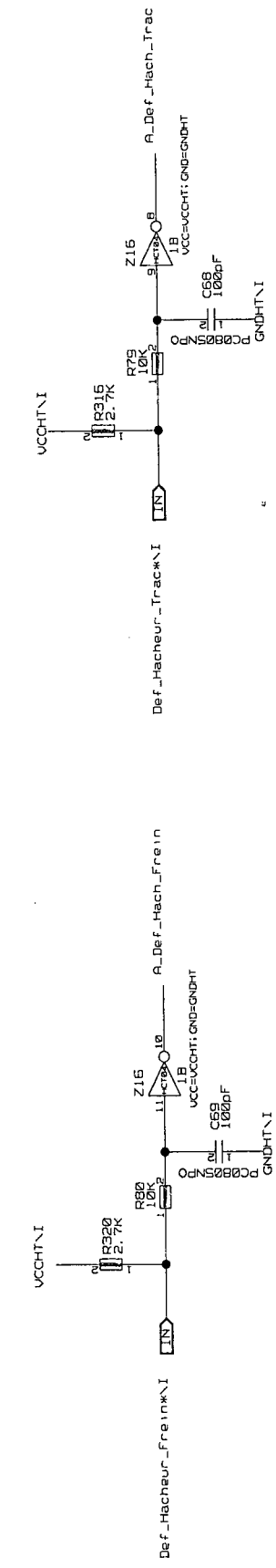

**VALABLE
POUR FABRICATION**

M49 SERIE TDS

IND	A1	11/96	DESIGNATION	CARTE-CALCULATrice	FEUILLE	sur	37
IND	B2	04/97	FORMAT	A2	SCHEMA DE PRINCIPe		
IND	D1	12/95	REVISION	CONTROLEUR-HT	NUMERO DE DOCUMENT		2162208a19 B2
SCHEMA DE PRINCIPe				ET DE RECAVION			
SOCIETE D'APPLICATIONS				GENERALITES D'ELECTRICITE			
Etabl				DATE			
RIBES				PAR			
MOM				VERIFIE			
NOM				MOM			
DATE				DATE			

IND	A1	11/96	DESIGNATION	CARTE-CALCULATrice	FEUILLE	sur	37
IND	B2	04/97	FORMAT	A2	SCHEMA DE PRINCIPe		
IND	D1	12/95	REVISION	CONTROLEUR-HT	NUMERO DE DOCUMENT		2162208a19 B2
SCHEMA DE PRINCIPe				ET DE RECAVION			
SOCIETE D'APPLICATIONS				GENERALITES D'ELECTRICITE			
Etabl				DATE			
RIBES				PAR			
MOM				VERIFIE			
NOM				MOM			
DATE				DATE			

Med Nov 6 09:59:32 1996

DRAWING: **3**

CONTROLEUR-HT
contraint

DE DOCUMENT EST LA PROPRIETE DE LA SOCIETE IL NE PEUT ETRE REPRODUIT OU COMMUNIQUE SANS AUTORISATION ECRIE

123456789101112131415161718192021222324252627282930313233343536373839404142434445464748495051525354555657585960616263646566676869707172737475767778798081828384858687888990919293949596979899100



**VALABLE
POUR FABRICATION**

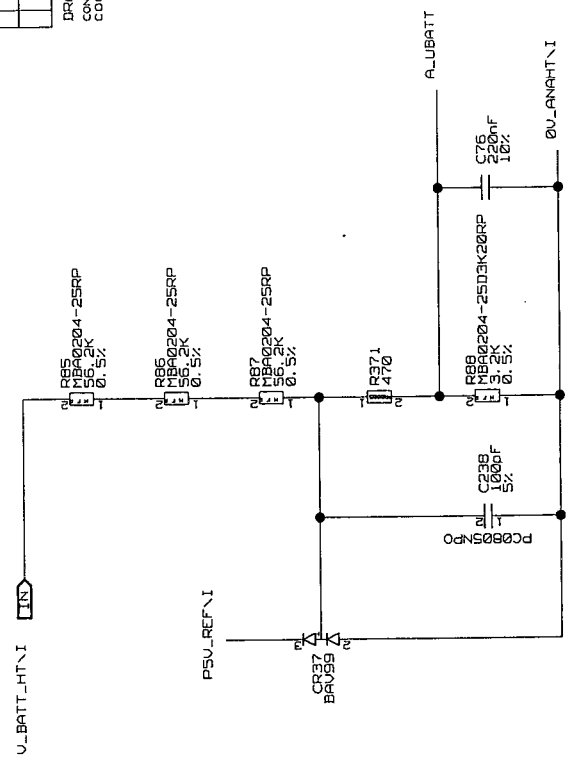

M49 SERIE TDS

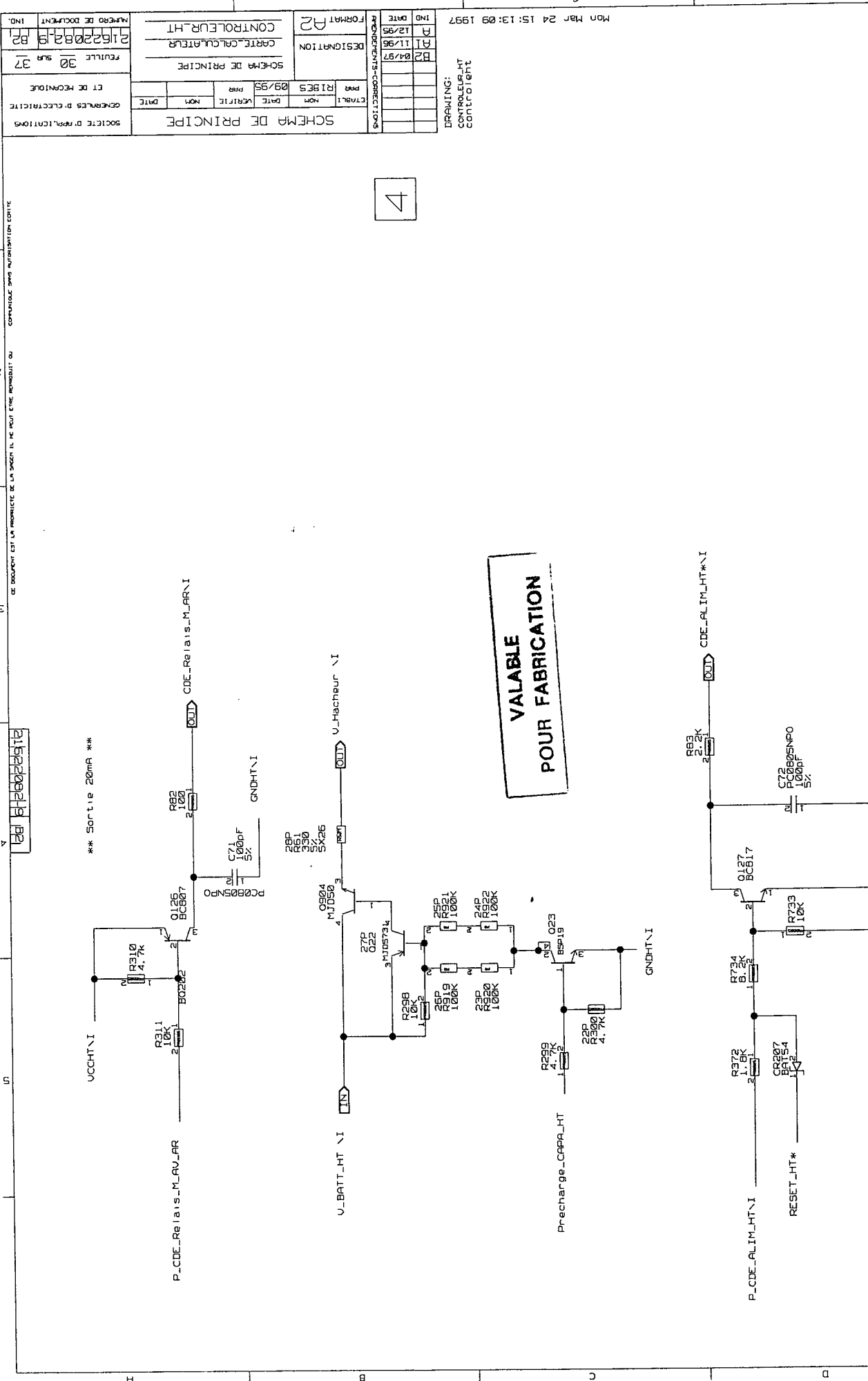

VALABLE
POUR FABRICATION

4

SCHEMA DE PRINCIPALE		SCHEMA DE PRINCIPALE	
GENERALES D'ELECTRICITE	ET DE MECANIQUE	FEUILLE 30 SUR 37	NUMERO DE DOCUMENT 21622208219 B2
SOCIETE D'APPLICATIONS		CARTE-CALCULATEUR	
CONTROLER-HT		CONTROLER-HT	
IND	DATE	FORMAT	A2
B1	12/95	DESIGNATION	CONTROLER-HT
B2	04/97	REVISIONS-CORRECTIONS	
B3	11/96	TABLE	
B4	09/95	PAR	
B5	09/95	RIBES	
B6	09/95	DATE	
B7	09/95	VERIFIE	
B8	09/95	NOM	
B9	09/95	DATE	
B10	09/95	DATE	

DRAWING:
CONTROLER-HT
CONTROLER-HT

Mon Mar 24 15:13:09 1997

CE DOCUMENT EST LA PROPRIETE DE LA DIRECTION DE LA RECHERCHE ET DEVEUT ETRE REMISE AU COMPTABLE SANS AUTANTION COPIE

123456789101112131415161718192021222324252627282930313233343536373839404142434445464748495051525354555657585960616263646566676869707172737475767778798081828384858687888990919293949596979899100

IND	A1	B1	B2
DATE	12/95	11/96	04/97
ÉTRAIT			
NOT			
DATE	09/95		
ÉCRITTE			
NOM			
PR			
RIBES	09/95		
FORMAT	A2		
DESIGNATION			

IND	A1	B1	B2
DATE	12/95	11/96	04/97
ÉTRAIT			
NOT			
DATE	09/95		
ÉCRITTE			
NOM			
PR			
RIBES	09/95		
FORMAT	A2		
DESIGNATION			

Mon Nov 4 16:18:45 1996

DRAWING:
contrôleur
CONTRÔLEUR-HT

5

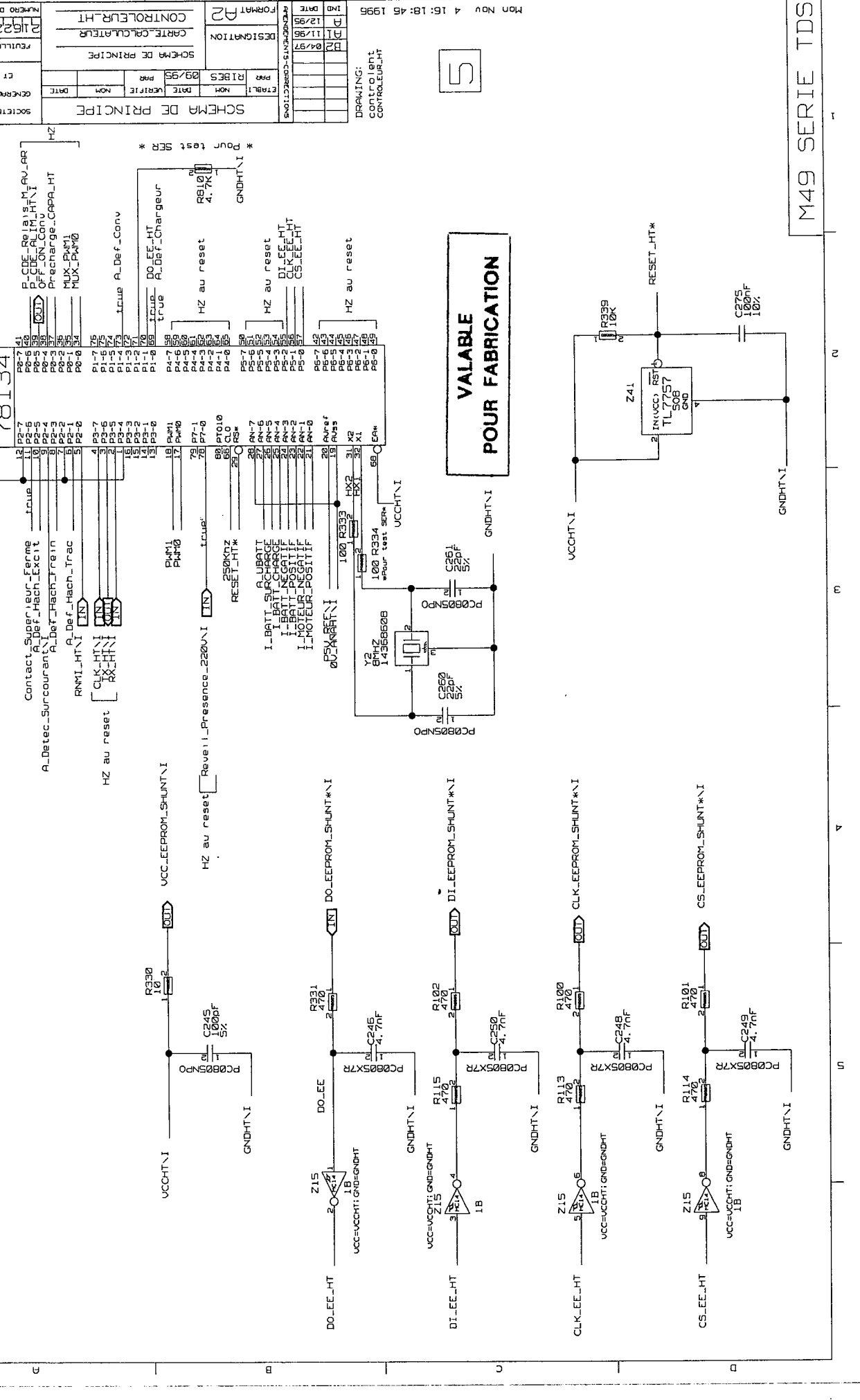

M49 SERIE TDS

SCHEMA DE PRINCIPALE		SCHEMA DE PRINCIPLE		REVISIONS	
IND	DATE	IND	DATE	IND	DATE
A1	11/96	A1	11/96	A1	11/96
B2	04/97	B2	04/97	B2	04/97
DESIGNATION		DESIGNATION		DESIGNATION	
CARTE CALCULATEUR HT		CARTE CALCULATEUR HT		CARTE CALCULATEUR HT	
FORMAT A2		FORMAT A2		FORMAT A2	
RIBES 09/95		RIBES 09/95		RIBES 09/95	
DATE	VERIFIE	DATE	VERIFIE	DATE	VERIFIE
SOCIETE D'APPLICATIONS		SOCIETE D'APPLICATIONS		SOCIETE D'APPLICATIONS	
CONCEPTION D'ELLECTRONIQUE		CONCEPTION D'ELLECTRONIQUE		CONCEPTION D'ELLECTRONIQUE	
ET DE RECONSTRUCTION		ET DE RECONSTRUCTION		ET DE RECONSTRUCTION	
REVISION 34 SUR 37		REVISION 34 SUR 37		REVISION 34 SUR 37	
NUMERO DE DOCUMENT		NUMERO DE DOCUMENT		NUMERO DE DOCUMENT	
IND. B2		IND. B2		IND. B2	

DRAWING: CONTROLLEUR HT
 07 29:29:05 Mar 1997

EBT HT
 Electronique BT reportee
 sur la carte HT

CE DOCUMENT EST LA PROPRIETE DE LA SOCIETE IL NE PEUT ETRE REPRODUIT OU COMMUNIQUE SANS AUTORISATION ECRIE

VALABLE
 POUR FABRICATION

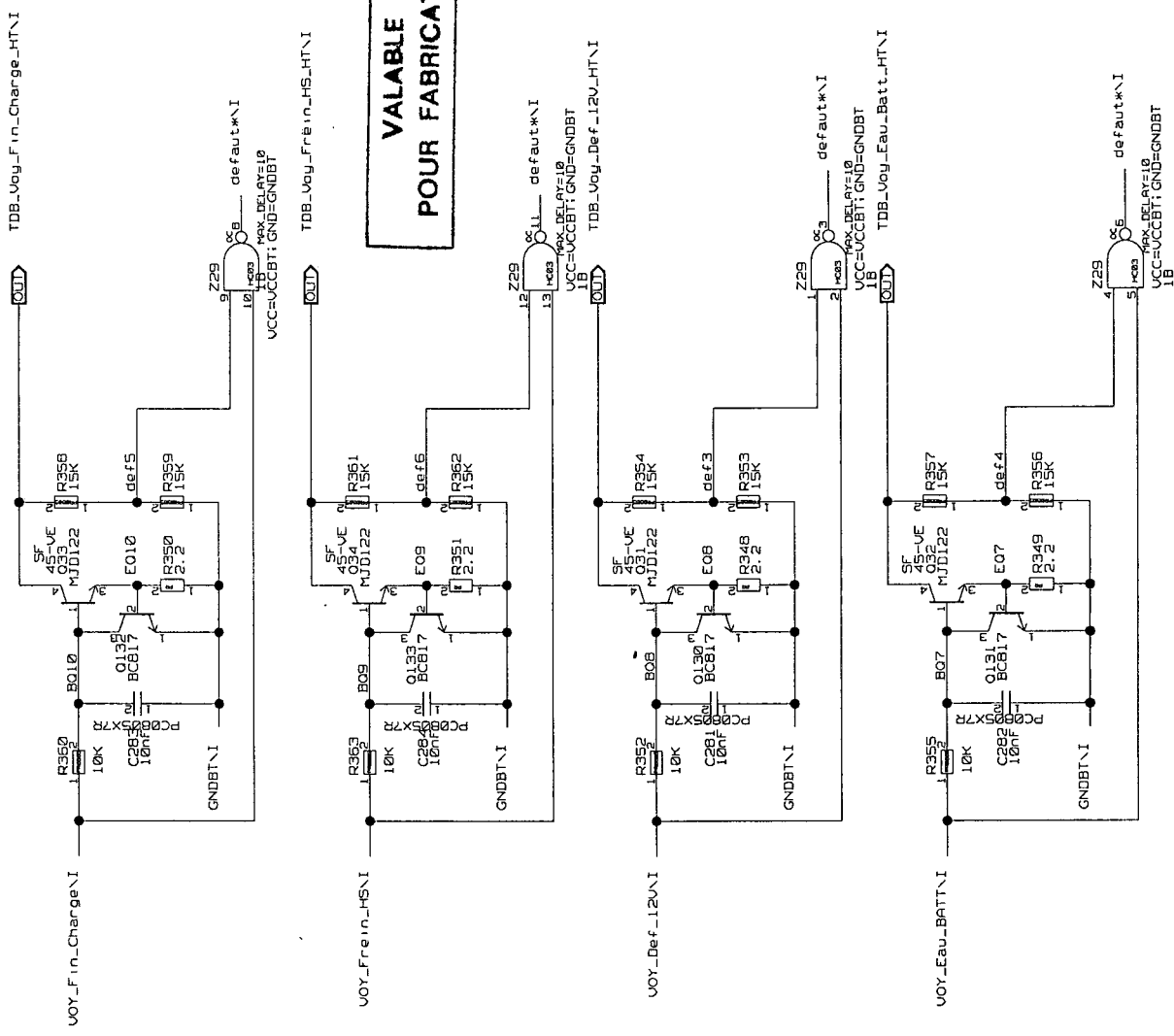

U N M V

C D

*** Signal Cross-Reference ***
 --- for the entire design ---

+12V 21B4< 2201> 33C4 37D3< 37A6< 37A1>
 +12V-BATT 1B3< 3C5< 4B5< 5C6< 7C3<
 +12V-BATT_R 3B5< 5C4< 9C2 9B3 10A2> 13C4 13B4
 14C3< 14B5< 14A5<
 +5V-ACCLE 1A3< 3B3< 4C4> 7A6>
 +5V-REFBT 5C1> 7C5< 7A2> 7A5 8B3 8B5 8A3 8A5
 11C4>
 +APC-APRES-DIODE-BT 2C2> 2C5< 2A5< 2A2> 3C5< 5B1>
 6B6< 9A2 26A4<
 +APC-ARRET_LUR 1B3< 3B5 4B3< 5B4<
 +APC-CAPTEUR_VITESSE 30E< 5A1> 10A6<
 0V-ANRBT 501> 7D4> 7D1> 7D5 7C5 7B4> 7A3<
 804> 8C2 8C5 8B2 8B5 11C4>
 0V-ANRHT 21A2> 2203< 2205< 23B5< 23B3< 29D4>
 29D1> 29C4> 29C4> 29B4> 29A4>
 31B3< 37D3<
 1B3< 3C5< 4B4< 5C3<
 1C6< 21A4< 22D3<
 1C6<
 1A3< 3B3 4C3> 7B5<
 33C5<
 204< 2D3> 3B3> 12B5> 26C5<
 204KHZ 151 63KHZ
 250KHZ 31B3< 33D6<
 6A5
 ACR17 13B4
 ACR34 13B4
 ACR501 11B4> 11B4> 11B4> 11B4> 11B4>
 AD <7... 0>
 11B4> 11B4> 12C3< 12B3< 12B3< 12B3<
 12B3< 12B3< 12B3< 12B3< 12A3<
 12A3< 12A3< 12A3< 12A3< 12A3< 12A3<
 12A3<
 11C4> 12C4<
 12C3
 20C4
 A2202 20B4
 A2203 19A4
 A2204 20A4
 A2205 19B4
 A-12V-BATT 7C1> 11B5<
 A-CONSIGN-FREIN 8C1> 11B5<
 A-CONS_LACC 7B4> 11B5<
 A-CS-EE 12A6
 A-DEF-CHARGEUR 28B4> 31B1>
 A-DEF_CONU 28B1> 31A1>
 A-DEF_HACH-EXCIT 28D4> 31A3<
 A-DEF_HACH-FREIN 28A4> 31A2<
 A-DEF_HACH-TRAC 28A1> 31A3<
 A-DEF_HACH-TRAC 9B3> 11B5<
 A-DEHAREUR 9B3> 11B5<
 A-DETEC-SURCOURANT 19D3< 21A2> 22B6< 27D2> 31A4<
 A-ENTREE-TOR-CONTACTEUR-FREIN 9A1> 11B6<
 A-PRISE-220V 9B1> 11B3>
 A-PRND 8C4> 11B5<
 A-SENS 5C4> 11B5<
 A-TEMP_BLOC 7C4> 11B5<
 A-TEMP_FEAU 8A4> 11B5<
 A-TEMP_MOT 8A1> 11B5<

POUR VALABLE FABRICATION

A-TOR-PB-NICO 9A4> 11B3>
 A-TOR-PORTE_OUV 10B1> 11B3>
 A-TRAPE 9D1> 11B3>
 A-UBATT 29D1> 31B3<
 B10-ZZ705 35C2 36A5<
 B12-ZZ705 35C3 36A5<
 B13-ZZ705 35D2 36B5<
 B4-Z1B 32D6 36C5<
 BATTERIE-LIGNE-K 1C2< 3D5< 4C4>> 13C2<>
 34A4
 B010 15B5
 B012 16C6
 B014 16D3
 B015 17D3
 B018 15A5
 B019 15A5
 B020 16C6
 B0200 19D3
 B0201 20D4
 B0202 30A5
 B0203 19A3
 B0204 20A5
 B021 16A6
 B023 17A3
 B024 15D5
 B025 15C5
 B026 17D5
 B029 16A3
 B030 16B6
 B031 17A5
 B032 17B5
 B055 26B4
 B07 34D4
 B08 34C4
 B09 34B4
 CAPT-VITESSE-ALIM 1B3> 3A5< 4B5< 10B5<
 CAPT-VITESSE-SIGNAL 1B3< 3A5< 4B4< 10C5<
 CDE-ALIM-HT * 1C4> 21C2> 23B3> 30D3>
 CDE-ETAT-CDE-DISCONTACTEUR 12D4> 12A1> 16D4<
 CDE-FERMETURE-DISCON 2B5< 2B2> 3A3> 11A3> 26B6
 CDE_ON-OFF-ALIM-BT 2C5< 2C2> 3B3> 6A2> 20B6< 22B3<
 CDE_ON-OFF_CONU 1B4> 21B2> 23A5> 33A2>
 CDE-OUVERTURE-DISCON 2D5< 2D2> 3A3> 11A3> 26D6<
 CDE-RELAIS-CHAUF_BATT 1A2> 3A3> 4B5> 17B4>
 CDE-RELAIS-COMBINE_POMPE 1A2> 3A3> 4B5> 17C2>
 CDE-RELAIS-FAUX-STOP 1B2> 3B3> 4B5> 17A2>
 CDE-RELAIS_F_RECUL 1A2> 3B3> 4B5> 17C4>
 CDE-RELAIS_GMV_FEAU 1C2> 3D3> 4B4> 15C4
 CDE-RELAIS_GMV_PTE_VITESSE 1A2> 3B3> 4B3> 17A4>
 CDE-RELAIS_MAR 1B4> 21B3> 23B5> 30A3>
 CDE-RELAIS_VENT_MOT 1A2> 3A3> 4B4> 15A4>
 CDE-RELAIS-WARNING 1A2> 3B3> 4B4> 15B4>
 CKUC 6A5 12C6<
 CLAMP-12V-BATT 7C3< 7A3<
 CLAMP_ACC 7A4> 7A2>
 CLAMP-FREIN 7A3< 8B2>
 CLAMP-PRND 7A2> 8B4>
 CLAMP_TEMP_FEAU 7A2> 8A4>
 CLAMP_TEMP_MOT 7A3< 8A2>

CLK_BT * 1C4 2B4< 2B3> 3B3> 11A1> 20C5<
 22B3<
 CLK-EE 11A4> 12A6<
 CLK-EEPROM_SHUNT * 1A4> 21B2> 23B5> 31C4>
 CLK-EE-HT 31C6< 31B1>
 CLK-HT 20C2> 21C4< 22B5< 31A3<
 CONSIGNE-ACCELE 1A3< 3B5< 4C5< 7B6<
 CONSIGNE-FREIN 1A3 3A5< 4C5 6C3<
 CONTACT_SUPERIEUR-FERME 27B2> 31A3<
 CO200 19D3
 CO203 19A4
 CO5 13A3
 CO70 13C4
 CS-EE 11A4> 12A6<
 CS-EEPROM_SHUNT * 1A4> 21B2> 23B3> 31D4>
 CS-EE-HT 31D6< 31B1>
 C-OUVERT * 24B5< 24B5< 26D5
 DEF1 15A5
 DEF10 16B5
 DEF11 16C5
 DEF12 16D5
 DEF13 16A2
 DEF14 16D2
 DEF15 17A5
 DEF16 17B5
 DEF17 17D5
 DEF18 17A2
 DEF19 17D2
 DEF2 15B5
 DEF3 34C4
 DEF4 34D4
 DEF5 34A4
 DEF6 34B4
 DEF7 15C5
 DEF8 15D5
 DEF9 16A5
 DEF9 * 2A4< 2A3> 3D3> 11B2 15D3> 15C3>
 15B3> 15A3> 16D1> 16D4> 16C4>
 16B4> 16B1> 16A4> 17D4> 17D1>
 17C4> 17C1> 17B4> 17B1> 21C2>
 34D2> 34C2> 34B3> 34B3>
 DEF_CHARG_220V * 1B6< 21B4< 23A5< 28B5<
 DEF-CONVERTISSEUR * 1B6< 21B4< 23A3> 28B3<
 DEF-HACHEUR-EXCITATION * 1B6< 21B4< 23B3> 28A5<
 DEF-HACHEUR-FREIN * 1B6 21B4< 23B3> 28A5<
 DEF-HACHEUR-TRAC * 1B6<
 DEF-HACHEUR-TRACT * 1B6<
 DEF-ISOLEMENT-BT * 2D5< 3C5 11B3>
 DEF-ISOLEMENT-HT * 2D2> 21C2> 35A1>
 DEMANDE_INV_SENS 1B3< 3B5< 4B4> 9C6<
 DETEC-DIALOG 3B5<
 DETEC-SURCOURANT * 1B6< 21A4< 23B5< 27D5<
 DIAG-LIGNE-K 1B2<> 3C5<> 4C3<> 19A2<>
 DI-EE 11B4> 12A6<
 DI-EEPROM_SHUNT * 1A4> 21B2> 23A5> 31C4>
 DI-EE-HT 31C6< 31B1>
 DO-EE 11B4> 12A5> 31B5
 DO-EEPROM_SHUNT * 1A4< 21B2< 23A3< 31B4<
 DO-EE-HT 31B6< 31B1> 36B5<

SCHEMA DE PRINCIPAL		SCHEMA DE PRINCIPAL	
ETABL	NOM	VERIFIE	DATE
RI	DESIGNATION	FORMA	IND
9/95	2	2	12/95
GENERALITES D'ELABORATION		GENERALITES D'ELABORATION	
SOCIETE D'APPLICATIONS		SOCIETE D'APPLICATIONS	
ET DE RECONSTRUCTION		ET DE RECONSTRUCTION	
REVISION 37		REVISION 37	
NOMBRE DE DOCUMENT 21622082-9		NOMBRE DE DOCUMENT 21622082-9	
IND		IND	
DATE		DATE	

M49 SERIE TDS

IND		A1 11/98		B2 04/97	
DATE		12/95			
DESIGNATION		FORMA R2			
SCHEMA DE PRINCIPLE		CARTE-CALCULATRICE			
RIBES		09/95			
DATE					
VERIFIE					
NOH					
DATE					
GENERALIS D'ELECTRICITE		SOCIETE D'APPLICATIONS		CT DE MECANIQUE	
REVISION		2		37	
NUMERO DE DOCUMENT		21622082-19		B2	
IND					

C283	PC0805X7R 34A5	C283	PC0805X7R 34A5
C284	PC0805X7R 34B5	C284	PC0805X7R 34B5
C285	PC0805X7R 35B4	C285	PC0805X7R 35B4
C286	PC1210M 35B4	C286	PC1210M 35B4
C287	PC0805NPO 35B4	C287	PC0805NPO 35B4
C288	PC0805NPO 5B4	C288	PC0805NPO 5B4
C289	PC0805NPO 26C2	C289	PC0805NPO 26C2
C29	PC0805NPO 10B2	C29	PC0805NPO 10B2
C290	PC0805NPO 26A2	C290	PC0805NPO 26A2
C291	PC0805X7R 26A4	C291	PC0805X7R 26A4
C292	PC1210M 35D4	C292	PC1210M 35D4
C293	PC0805NPO 5B4	C293	PC0805NPO 5B4
C294	PC0805X7R 24C4	C294	PC0805X7R 24C4
C295	PC0805X7R 24C3	C295	PC0805X7R 24C3
C3	PC0805NPO 8A3	C3	PC0805NPO 8A3
C30	PC0805NPO 10B5	C30	PC0805NPO 10B5
C31	PC0805NPO 14D1	C31	PC0805NPO 14D1
C32	PC0805X7R 5C3	C32	PC0805X7R 5C3
C33	PC0805X7R 5C2	C33	PC0805X7R 5C2
C34	PC0805X7R 5C4	C34	PC0805X7R 5C4
C35	PC0805X7R 5D3	C35	PC0805X7R 5D3
C36	PC0805X7R 5D4	C36	PC0805X7R 5D4
C37	PC0805NPO 10D5	C37	PC0805NPO 10D5
C38	PC0805NPO 14B5	C38	PC0805NPO 14B5
C39	PC0805NPO 8A5	C39	PC0805NPO 8A5
C4	PC0805NPO 14A3	C4	PC0805NPO 14A3
C40	PC0805NPO 16A2	C40	PC0805NPO 16A2
C41	PC0805NPO 16C5	C41	PC0805NPO 16C5
C42	PC0805NPO 15D2	C42	PC0805NPO 15D2
C43	PC0805NPO 15B2	C43	PC0805NPO 15B2
C44	PC0805NPO 15C2	C44	PC0805NPO 15C2
C45	PC0805NPO 15D4	C45	PC0805NPO 15D4
C46	PC0805NPO 16C5	C46	PC0805NPO 16C5
C47	PC0805NPO 16D2	C47	PC0805NPO 16D2
C48	PC0805NPO 17D4	C48	PC0805NPO 17D4
C49	PC0805NPO 8C5	C49	PC0805NPO 8C5
C5	PC0805NPO 15B2	C5	PC0805NPO 15B2
C50	PC0805NPO 16B5	C50	PC0805NPO 16B5
C51	PC0805NPO 16A5	C51	PC0805NPO 16A5
C52	PC0805NPO 17A2	C52	PC0805NPO 17A2
C53	PC0805NPO 17D2	C53	PC0805NPO 17D2
C54	PC0805NPO 15B4	C54	PC0805NPO 15B4
C55	PC0805NPO 17A4	C55	PC0805NPO 17A4
C56	PC0805NPO 17B2	C56	PC0805NPO 17B2
C57	PC0805NPO 15C4	C57	PC0805NPO 15C4
C58	PC0805NPO 13A2	C58	PC0805NPO 13A2
C6	PC0805NPO 5B3	C6	PC0805NPO 5B3
C60	PC0805NPO 17B4	C60	PC0805NPO 17B4
C61	PC0805NPO 7C3	C61	PC0805NPO 7C3
C62	PC0805X7R 5D3	C62	PC0805X7R 5D3
C63	PC0805X7R 5D2	C63	PC0805X7R 5D2
C64	PC0805X7R 5D3	C64	PC0805X7R 5D3
C65	PC0805X7R 5D2	C65	PC0805X7R 5D2
C66	PC0805NPO 35C3	C66	PC0805NPO 35C3
C67	PC0805NPO 26B2	C67	PC0805NPO 26B2
C68	PC0805NPO 26B5	C68	PC0805NPO 26B5
C69	PC0805NPO 13D2	C69	PC0805NPO 13D2
C7		C7	

C227	PC0805X7R 15A5	C227	PC0805X7R 15A5
C228	PC0805X7R 16A6	C228	PC0805X7R 16A6
C229	PC0805X7R 16C6	C229	PC0805X7R 16C6
C23	PC0805X7R 7B4	C23	PC0805X7R 7B4
C230	PC0805X7R 17D3	C230	PC0805X7R 17D3
C231	PC0805X7R 15D5	C231	PC0805X7R 15D5
C232	PC0805X7R 17D5	C232	PC0805X7R 17D5
C233	PC0805X7R 15C5	C233	PC0805X7R 15C5
C234	PC0805X7R 17A3	C234	PC0805X7R 17A3
C235	PC0805NPO 5B5	C235	PC0805NPO 5B5
C236	PC0805NPO 32B3	C236	PC0805NPO 32B3
C237	PC0805NPO 32D3	C237	PC0805NPO 32D3
C238	PC0805NPO 29D2	C238	PC0805NPO 29D2
C239	PC0805X7R 27B5	C239	PC0805X7R 27B5
C24	CAPACHIMRAD 11C5	C24	CAPACHIMRAD 11C5
C240	PC0805X7R 27B6	C240	PC0805X7R 27B6
C241	PC0805NPO 27D4	C241	PC0805NPO 27D4
C242	PC0805X7R 25C3	C242	PC0805X7R 25C3
C243	PC0805X7R 25C3	C243	PC0805X7R 25C3
C244	PC0805NPO 22D5	C244	PC0805NPO 22D5
C245	PC0805NPO 31B5	C245	PC0805NPO 31B5
C246	PC0805X7R 31B5	C246	PC0805X7R 31B5
C247	PC0805NPO 33B3	C247	PC0805NPO 33B3
C248	PC0805X7R 31D5	C248	PC0805X7R 31D5
C249	PC0805X7R 31D5	C249	PC0805X7R 31D5
C25	PC0805X7R 6B4	C25	PC0805X7R 6B4
C250	PC0805X7R 31C5	C250	PC0805X7R 31C5
C251	PC0805NPO 28C5	C251	PC0805NPO 28C5
C252	PC0805NPO 28D2	C252	PC0805NPO 28D2
C253	PC0805NPO 28B2	C253	PC0805NPO 28B2
C254	PC0805X7R 29D5	C254	PC0805X7R 29D5
C255	PC0805X7R 29C5	C255	PC0805X7R 29C5
C256	PC0805X7R 29B5	C256	PC0805X7R 29B5
C257	PC0805X7R 29C5	C257	PC0805X7R 29C5
C258	PC0805X7R 29A5	C258	PC0805X7R 29A5
C259	PC0805X7R 29B5	C259	PC0805X7R 29B5
C26	PC0805X7R 10D5	C26	PC0805X7R 10D5
C260	PC0805NPO 31C3	C260	PC0805NPO 31C3
C261	PC0805NPO 25B4	C261	PC0805NPO 25B4
C262	PC1210M 25B4	C262	PC1210M 25B4
C263	PC0805NPO 25B4	C263	PC0805NPO 25B4
C264	PC0805X7R 25B5	C264	PC0805X7R 25B5
C266	PC0805X7R 25B4	C266	PC0805X7R 25B4
C267	PC1210M 25B5	C267	PC1210M 25B5
C27	PC0805X7R 5C3	C27	PC0805X7R 5C3
C270	PC1206 37B5	C270	PC1206 37B5
C271	PC0805NPO 37C4	C271	PC0805NPO 37C4
C272	PC0805X7R 37C5	C272	PC0805X7R 37C5
C273	PC0805X7R 25C4	C273	PC0805X7R 25C4
C274	PC0805X7R 25C3	C274	PC0805X7R 25C3
C275	PC1210M 31D2	C275	PC1210M 31D2
C276	PC0805X7R 20D3	C276	PC0805X7R 20D3
C277	PC0805X7R 20C3	C277	PC0805X7R 20C3
C278	PC0805NPO 20B5	C278	PC0805NPO 20B5
C279	PC0805X7R 20B4	C279	PC0805X7R 20B4
C28	PC0805NPO 9D3	C28	PC0805NPO 9D3
C280	PC0805X7R 24C5	C280	PC0805X7R 24C5
C281	PC0805X7R 34C5	C281	PC0805X7R 34C5
C282	PC0805X7R 34D5	C282	PC0805X7R 34D5

*** Unit Cross-Reference ***
 --- for the entire design ---

C1	PC0805NPO 7A5	C1	PC0805NPO 7A5
C10	ANTIPARASIT 35B5	C10	ANTIPARASIT 35B5
C101	PC0805X7R 20B4	C101	PC0805X7R 20B4
C102	CAPACHIMRAD 37B3	C102	CAPACHIMRAD 37B3
C103	PC0805X7R 26C3	C103	PC0805X7R 26C3
C104	CAPACHIMRAD 26B2	C104	CAPACHIMRAD 26B2
C105	PC0805X7R 26B3	C105	PC0805X7R 26B3
C105	PC0805X7R 24C5	C105	PC0805X7R 24C5
C107	PC0805X7R 24C5	C107	PC0805X7R 24C5
C108	PC0805X7R 24C4	C108	PC0805X7R 24C4
C109	PC0805X7R 24C3	C109	PC0805X7R 24C3
C11	PC0805NPO 9C5	C11	PC0805NPO 9C5
C110	PC0805X7R 26D1	C110	PC0805X7R 26D1
C111	PC0805X7R 26D2	C111	PC0805X7R 26D2
C112	PC1210M 35A2	C112	PC1210M 35A2
C113	PC0805X7R 35B3	C113	PC0805X7R 35B3
C114	CAPACHIMRAD 37A5	C114	CAPACHIMRAD 37A5
C115	PC0805NPO 8C3	C115	PC0805NPO 8C3
C12	PC0805NPO 7B5	C12	PC0805NPO 7B5
C13	PC0805NPO 8D5	C13	PC0805NPO 8D5
C14	PC0805X7R 5D3	C14	PC0805X7R 5D3
C15	PC0805X7R 5C1	C15	PC0805X7R 5C1
C16	PC0805X7R 6C4	C16	PC0805X7R 6C4
C17	PC0805X7R 8A2	C17	PC0805X7R 8A2
C19	PC0805X7R 7D2	C19	PC0805X7R 7D2
C2	PC0805NPO 7B5	C2	PC0805NPO 7B5
C22	PC0805X7R 8A4	C22	PC0805X7R 8A4
C200	PC0805NPO 24C2	C200	PC0805NPO 24C2
C203	PC0805NPO 5C5	C203	PC0805NPO 5C5
C204	PC0805X7R 5C5	C204	PC0805X7R 5C5
C205	PC1210M 5C6	C205	PC1210M 5C6
C206	PC0805NPO 5C4	C206	PC0805NPO 5C4
C207	PC0805X7R 5C5	C207	PC0805X7R 5C5
C208	PC1210M 5C5	C208	PC1210M 5C5
C209	PC0805NPO 24C2	C209	PC0805NPO 24C2
C21	PC0805X7R 7C5	C21	PC0805X7R 7C5
C210	PC0805X7R 5C3	C210	PC0805X7R 5C3
C211	PC1210M 11D5	C211	PC1210M 11D5
C212	PC0805NPO 11B5	C212	PC0805NPO 11B5
C213	PC0805NPO 11B6	C213	PC0805NPO 11B6
C214	PC0805NPO 5B5	C214	PC0805NPO 5B5
C215	PC0805X7R 6A5	C215	PC0805X7R 6A5
C216	PC0805X7R 17C3	C216	PC0805X7R 17C3
C217	PC0805X7R 16D6	C217	PC0805X7R 16D6
C218	PC0805X7R 15B5	C218	PC0805X7R 15B5
C219	PC0805X7R 16D3	C219	PC0805X7R 16D3
C22	PC0805X7R 8C2	C22	PC0805X7R 8C2
C222	PC0805X7R 5C2	C222	PC0805X7R 5C2
C221	PC0805X7R 5C2	C221	PC0805X7R 5C2
C223	PC0805X7R 17A5	C223	PC0805X7R 17A5
C224	PC0805X7R 16B6	C224	PC0805X7R 16B6
C225	PC0805X7R 16A3	C225	PC0805X7R 16A3
C226	PC0805X7R 17C5	C226	PC0805X7R 17C5

POUR FABRICATION

CE DOCUMENT EST LA PROPRIETE DE LA SOCIETE DE LA PAGE 11. NE PAS ETRE REMBOUTI OU COMMUNIQUE SANS AUTORISATION ECRIE

U

V

W

X

Y

Z

AA

AB

SCHEMA DE PRINCIPALE		SCHEMA DE PRINCIPALE	
GENERALITES D'ELLECTRICITE		GENERALITES D'ELLECTRICITE	
ET DE MECANIQUE		ET DE MECANIQUE	
REVISION 37		REVISION 37	
N° DE DOCUMENT 216220219		N° DE DOCUMENT 216220219	
IND. 12/95		IND. 12/95	
DATE 04/97		DATE 04/97	
IND. 12/95		IND. 12/95	
DATE 04/97		DATE 04/97	
IND. 12/95		IND. 12/95	
DATE 04/97		DATE 04/97	

CR7	ZENER	901
CR8	ZENER	9A2
CR9	ZENER	9C4
CR900	DIODE	5A3
CR901	ZENER	14D2
CR902	SCHOTTKY	35B3
G1	CONN'FSP16P21	2A3
G2	CONN'FSP16P21	2C4
HSST11	ETOILE	22D4
HSST17	ETOILE	37C4
L1	INDUCTANCE2P	11C5
L2	INDUCTANCE2P	37A5
P1	CONN'SSVAHP	4B4
P2	HE1040	23A4
P3	CONN'2P	23C4
PP400	CHASSIS	5A6
PP401	CHASSIS	5A5
PP402	CHASSIS	5A5
PP403	CHASSIS	5A5
PP404	CHASSIS	5A4
PP405	CHASSIS	24C3
PP406	CHASSIS	24C2
O1	BC817	14B5
O10	MJD122	17A5
O100	BC817	13D3
O101	BC817	13A3
O102	BC817	14B4
O103	BC817	14B4
O106	BC807	10B4
O107	BC817	17B3
O108	BC817	16D5
O109	BC817	15B5
O11	MJD122	16A2
O110	BC817	16D3
O111	BC817	17A5
O112	BC817	16B5
O113	BC817	15A5
O114	BC817	16A5
O115	BC817	15D5
O116	BC817	17D5
O117	BC817	16A3
O118	BC817	17B5
O119	BC817	16C5
O12	MJD122	16B5
O120	BC817	17D3
O121	BC817	15C5
O122	BC817	17A5
O123	BC807	32A4
O124	BC807	33A5
O125	BC807	33A5
O126	BC807	30A4
O127	BC817	30D4
O128	BC807	33A3
O129	BC817	20D4
O13	MJD122	17B5
O130	BC817	34C4
O131	BC817	34D4
O132	BC817	34A4
O133	BC817	34B4

VALABLE POUR FABRICATION

C935	PC1210M	35D4
C94	CAPACITIMRAD	37A2
C95	PC0805NFO	20D2
C96	PC0805X7R	20D3
C97	PC0805NFO	20C3
C98	PC0805X7R	25C5
C99	PC0805X7R	25C5
CR1	ZENER	1303
CR10	ZENER	9B4
CR11	ZENER	10D4
CR12	ZENER	14B4
CR13	ZENER	14A4
CR15	DIODE	16A2
CR16	DIODE	15D2
CR17	DIODE	16C5
CR18	DIODE	15A2
CR19	DIODE	15B2
CR2	ZENER	13B3
CR20	DIODE	16A5
CR200	DIODES	13B5
CR201	DIODE	9D3
CR202	DIODE	10B5
CR203	SCHOTTKY	10C5
CR204	ZENER	9A5
CR205	SCHOTTKY	6A5
CR206	ZENER	6B4
CR207	SCHOTTKY	30D5
CR208	DIODE	26A3
CR209	DIODE	26B4
CR21	DIODE	15C2
CR210	ZENER	26B3
CR22	DIODE	15C4
CR23	DIODE	16B5
CR24	DIODE	16A5
CR25	DIODE	16C2
CR26	DIODE	17A2
CR27	DIODE	17C5
CR28	DIODE	15B4
CR3	DIODE	17A5
CR30	DIODE	13B3
CR31	DIODE	15A4
CR32	DIODE	17B5
CR33	DIODE	15C4
CR34	DIODE	17B2
CR35	DIODE	5B3
CR36	DIODE	5C5
CR37	DIODES	29C3
CR38	ZENER	37A5
CR39	DIODE	37A6
CR4	DIODE	13C3
CR40	DIODECHS	37A3
CR41	DIODECHS	37A2
CR42	DIODECHS	37A5
CR43	DIODECHS	37B2
CR44	DIODE	26B3
CR45	TRANSILLUMID	26B3
CR5	ZENER	9C2
CR6	ZENER	10B2

C70	PC0805NFO	28D5
C71	PC0805NFO	30A4
C72	PC0805NFO	30D4
C73	PC0805NFO	27D5
C74	CAPACITIMRAD	37D2
C75	CAPACITIMRAD	37D2
C76	PC1210M	29D2
C77	PC0805X7R	25C4
C78	PC0805X7R	25C2
C79	PC0805NFO	26B5
C8	PC0805NFO	9A2
C80	PC0805NFO	29A5
C81	PC0805NFO	29C5
C82	PC0805NFO	29B5
C83	PC0805NFO	29C5
C84	PC0805NFO	29D5
C85	PC1210M	33C4
C86	PC0805X7R	37B5
C87	CAPACITIMRAD	37C3
C88	PC1210M	37A4
C89	CAPACITIMRAD	37A4
C9	PC0805NFO	9C2
C90	CP4N	37C3
C900	PC0805NFO	26D1
C902	CAPACITIMRAD	37B2
C903	CAPACITIMRAD	5B2
C904	PC0805NFO	12A4
C905	PC0805NFO	12B4
C906	PC0805NFO	12A6
C908	PC0805X7R	5C4
C909	PC0805NFO	26B5
C91	PC0805NFO	32A3
C910	PC0805NFO	12C5
C911	PC0805NFO	12C5
C912	PC0805NFO	12C5
C913	PC0805NFO	12D5
C914	PC0805NFO	12D5
C915	PC0805NFO	12D5
C916	PC0805NFO	12D5
C917	PC0805NFO	12C4
C918	PC0805NFO	12C4
C919	PC0805NFO	12C4
C92	PC0805NFO	37B4
C920	PC0805NFO	12D4
C921	PC0805NFO	12D4
C922	PC0805NFO	12D4
C923	PC0805NFO	12C3
C924	PC0805NFO	12D3
C925	PC0805NFO	12D3
C926	CAPACITIMRAD	13C4
C927	PC0805NFO	26B6
C928	PC0805NFO	26D5
C929	PC0805NFO	26D5
C93	CAPACITIMRAD	37A2
C930	PC0805NFO	26D5
C931	PC0805NFO	27B4
C932	PC0805NFO	27B4
C933	PC0805NFO	9A5
C934	PC0805NFO	9D5

CE DOCUMENT EST LA PROPRIETE DE LA SOCIETE M. POUR ETRE REMISE AU COMMANDEUR DANS L'AUTORISATION CORRE

U

U

U

U

U

U

U

U

U

U

IND DATE		R1 11/96		R2 04/97		R3 12/95	
DESIGNATION		A2		A2		A2	
SCHEMA DE PRINCIPES		CARTES CALCULATEUR		2		216222222222222222	
GENERALIS D'ELCTRICITE		ET DE MECANIQUE		REVUE 2		sur 37	
SCHEMA DE PRINCIPES		GENERALIS D'ELCTRICITE		ET DE MECANIQUE		REVUE 2	
ETABL	NOM	RI	DATE	VERIFIE	PAR	DATE	PAR
REVISIONS-CONDICTIONS							

R219	PR0805	1885
R220	PR0805	785
R221	PR0805	1445
R222	PR0805	9A5
R223	PR0805	10B4
R224	PR0805	10B4
R225	PR0805	6A4
R226	PR0805	6A4
R227	PR0805	6A4
R228	PR0805	6A4
R229	PR0805	17B3
R230	PR0805	785
R231	PR0805	17C2
R232	PR0805	17B2
R233	PR0805	16C5
R234	PR0805	16D5
R235	PR	16C6
R236	PR	15B5
R237	PR	17C3
R238	PR	16D2
R239	PR	16D5
R240	PR0805	15B6
R241	PR0805	8A3
R242	PR0805	15B5
R243	PR0805	15B5
R244	PR0805	16D2
R245	PR0805	16D3
R246	PR0805	12B3
R247	PR	7C2
R248	PR	6B5
R249	PR0805	6B5
R250	PR0805	8A3
R251	PR0805	17A6
R252	PR0805	17A5
R253	PR0805	16B5
R254	PR0805	16B5
R255	PR0805	16B6
R256	PR0805	15A5
R257	PR0805	15A5
R258	PR0805	15A5
R259	PR0805	16A5
R260	PR0805	8A5
R261	PR0805	16A5
R262	PR0805	16A5
R263	PR0805	15D5
R264	PR0805	15D5
R265	PR0805	17D5
R266	PR0805	17D5
R267	PR0805	17D6
R268	PR	16A2
R269	PR	17A5
R270	PR	17C5
R271	PR	16B5
R272	PR	16C5
R273	PR	15A5
R274	PR	17D3
R275	PR	16A5

VALABLE
POUR FABRICATION

R119	PR0805	26B2
R120	PR0805	7D2
R121	PR0805	20C3
R122	PR0805	20C3
R123	PR0805	20D4
R124	PR0805	20D4
R125	PR0805	20B3
R126	PR0805	20A3
R127	PR0805	19A3
R128	PR0805	19A3
R129	PR0805	19C3
R130	PR0805	8A5
R131	PR0805	19D3
R132	PR0805	19D3
R133	RC30	37C3
R134	PR0805	20A4
R135	RESMFR	26D3
R136	RESMFR	26D2
R137	PR0805	26C4
R138	PR0805	26B6
R139	PR0805	8A2
R140	PR0805	35B3
R141	PR0805	35B3
R142	PR0805	35B4
R143	PR0805	35A4
R144	PR0805	35A3
R145	PR0805	35A2
R146	PR0805	35B5
R147	PR0805	26D2
R148	PR0805	26D2
R149	PR0805	26C1
R150	PR0805	8C2
R151	PR0805	35C2
R152	PR0805	35D3
R153	PR0805	7B5
R154	PR	7A5
R155	PR	7B5
R156	PR0805	7C5
R157	PR0805	8C3
R158	PR0805	13D4
R159	PR0805	13B4
R160	PR0805	13C5
R161	PR0805	11B5
R162	PR0805	11A5
R163	PR	9D2
R164	PR	9D2
R165	PR0805	8B3
R166	PR0805	8B4
R167	PR	9B5
R168	PR	9B5
R169	PR	10C5
R170	PR0805	10C5
R171	PR0805	14B5
R172	PR0805	9A4
R173	PR0805	11D2

G134	MBT5551	26B4
O14	MJD122	15A5
O15	MJD122	16C5
O16	MJD122	16A5
O17	MJD122	17D3
O18	MJD122	15D5
O19	MJD122	15C5
O20	BCB17	14A4
O21	MJD122	17D5
O22	MJD122	17A3
O23	MJD5731	30B5
O24	BSP19	30C4
O25	BCB07	32B4
O26	BCB07	32D4
O27	BCB07	32C4
O28	BCB17	33C4
O29	BCB17	19A3
O30	BCB17	19D3
O31	BCB17	11D2
O32	BCB17	20A5
O33	MJD122	34C4
O34	MJD122	34D4
O35	MJD122	34A4
O36	MJD122	34B4
O37	IRF530	37B3
O38	IRF530	26C3
O39	IRF530	26B3
O40	IRF530	10B5
O41	MJD122	17B3
O42	MJD122	15B5
O43	MJD122	16D2
O44	BCB17	14D2
O45	BCB17	14D3
O46	BCB17	13D4
O47	BCB17	13B4
O48	MJD50	30B4
O49	CTN	7D5
O50	PR0805	8C5
O51	PR0805	31C5
O52	PR0805	31D5
O53	PR0805	31C5
O54	PR0805	28B5
O55	PR0805	28C2
O56	PR	32A3
O57	PR	37A5
O58	PR0805	37B6
O59	PR0805	37C6
O60	PR0805	7C2
O61	PR0805	37B5
O62	PR0805	37B4
O63	RC30	31C5
O64	PR0805	31D5
O65	PR0805	31C5
O66	PR0805	28B5
O67	PR0805	28C2
O68	PR0805	28B2

CE DOCUMENT EST LA PROPRIETE DE LA SOCIETE IL NE PEUT ETRE REPRODUIT OU COMMUNIQUE SANS AUTORISATION ECRIE

la fabrication

SCHEMA DE PRINCIPAL		SCHEMA DE PRINCIPAL	
GENERALES D'LECTRICI	ET DE TECNIOLE	REUILLE 7 SUR 37	NUMERO DE DOCUMENT 21622009
SOCIETE D'APPLICATIONS		IND. 11/96	
DATE		IND. 12/95	
VERIFIC		DESIGNATION	
RIBES		FORMAT A2	
DATE 09/95		REVISIONS-CORRECTI	

CE DOCUMENT EST LA PROPRIETE DE LA SOCIETE IL NE PEUT ETRE REPRODUIT OU COMMUNIQUE SANS AUTORIZATION ECRIE

R51	PR	R51	9C5
R52	PR0805	R52	14C5
R53	PR0805	R53	14B5
R54	PR0805	R54	14C4
R55	PR0805	R55	14A5
R56	PR0805	R56	14A4
R57	PR0805	R57	12C5
R58	PR0805	R58	12A3
R59	PR0805	R59	13B4
R6	PR0805	R6	30B4
R61	R857	R61	27A5
R62	PR0805	R62	27B5
R63	PR0805	R63	27B5
R64	PR0805	R64	27A3
R65	PR0805	R65	27A5
R66	PR0805	R66	27A5
R67	PR0805	R67	32B4
R68	PR0805	R68	32B5
R69	PR0805	R69	32B4
R7	PR0805	R7	13B5
R70	PR0805	R70	32B5
R71	PR0805	R71	32D5
R72	PR0805	R72	32D5
R73	PR0805	R73	32D4
R733	PR0805	R733	30D4
R734	PR0805	R734	30D5
R74	PR0805	R74	32C5
R75	PR0805	R75	32C5
R76	PR0805	R76	33A6
R77	PR0805	R77	32C4
R78	PR0805	R78	32C3
R79	PR0805	R79	28A2
R8	PR0805	R8	13B5
R80	PR0805	R80	28A5
R81	PR0805	R81	28C5
R810	PR0805	R810	31B1
R82	PR0805	R82	30A4
R83	PR0805	R83	30C4
R84	PR0805	R84	27C5
R85	RESMFR	R85	29B2
R86	RESMFR	R86	29C2
R87	RESMFR	R87	29C2
R88	RESMFR	R88	29D2
R89	PR0805	R89	37C3
R9	PR0805	R9	13B5
R90	PR0805	R90	33C4
R900	PR0805	R900	13C5
R901	PR0805	R901	26B4
R902	PR0805	R902	6C5
R903	PR0805	R903	12A6
R904	PR0805	R904	14C3
R905	PR0805	R905	14C3
R906	PR0805	R906	14D3
R907	PR0805	R907	14D2
R908	PR0805	R908	26D3
R91	PR0805	R91	33C5
R910	PR0805	R910	13D3
R911	PR	R911	13C3
R912	PR	R912	13C3

POUR VALABLE FABRICATION

R33	PR	R33	9A5
R330	PR0805	R330	31B5
R331	PR0805	R331	31B5
R332	PR0805	R332	33A2
R333	PR0805	R333	31B3
R334	PR0805	R334	31C3
R335	PR0805	R335	37B4
R336	PR0805	R336	37B4
R337	PR0805	R337	33A3
R338	PR0805	R338	33A3
R339	PR0805	R339	31D2
R34	PR0805	R34	6B5
R340	PR0805	R340	20C4
R341	PR0805	R341	20B4
R342	PR0805	R342	20A5
R343	PR0805	R343	20B5
R344	PR0805	R344	20A5
R345	PR0805	R345	19A4
R346	PR0805	R346	19B4
R347	PR0805	R347	19C4
R348	PR	R348	34C4
R349	PR	R349	34D4
R35	PR0805	R35	8C5
R350	PR	R350	34A4
R351	PR	R351	34B4
R352	PR0805	R352	34C5
R353	PR0805	R353	34C4
R354	PR0805	R354	34C4
R355	PR0805	R355	34D5
R356	PR0805	R356	34D4
R357	PR0805	R357	34D4
R358	PR0805	R358	34A4
R359	PR0805	R359	34A4
R360	PR0805	R360	34A5
R361	PR0805	R361	34B4
R362	PR0805	R362	34B4
R363	PR0805	R363	34B5
R364	PR0805	R364	35B4
R365	PR0805	R365	26C2
R366	PR0805	R366	26B3
R367	PR0805	R367	26B4
R368	PR0805	R368	26B4
R369	PR0805	R369	35D6
R370	PR0805	R370	35D5
R371	PR0805	R371	29C2
R372	PR0805	R372	30D5
R4	PR0805	R4	13A4
R40	PR	R40	9B3
R41	PR	R41	9B2
R42	PR0805	R42	9B2
R43	PR0805	R43	10B2
R44	PR	R44	10A3
R45	PR	R45	9A3
R46	PR	R46	9A2
R47	PR	R47	9A2
R48	PR0805	R48	9A2
R49	PR0805	R49	9C5
R5	PR0805	R5	13C5
R50	PR	R50	9C5

R276	PR	R276	15C5
R277	PR	R277	15D5
R278	PR	R278	17A3
R279	PR	R279	17D5
R280	PR0805	R280	16A3
R281	PR0805	R281	16A2
R282	PR0805	R282	16A2
R283	PR0805	R283	17B5
R284	PR0805	R284	17C5
R285	PR0805	R285	17B6
R286	PR0805	R286	16C6
R287	PR0805	R287	16C5
R288	PR0805	R288	16C5
R289	PR0805	R289	17D2
R29	PR0805	R29	5D2
R290	PR0805	R290	17D2
R291	PR0805	R291	17D3
R292	PR0805	R292	15C5
R293	PR0805	R293	15C5
R294	PR0805	R294	15C5
R295	PR0805	R295	17A2
R296	PR0805	R296	17A2
R297	PR0805	R297	17A3
R298	PR0805	R298	30B5
R299	PR0805	R299	30C5
R3	PR0805	R3	13C4
R30	PR0805	R30	11B2
R300	PR0805	R300	30C5
R301	PR0805	R301	27B5
R302	PR0805	R302	27B5
R303	PR0805	R303	27A5
R304	PR0805	R304	32A4
R305	PR0805	R305	32A5
R306	PR0805	R306	32A4
R307	PR0805	R307	32A5
R308	PR0805	R308	32D4
R309	PR0805	R309	32C4
R31	PR0805	R31	12A5
R310	PR0805	R310	30A5
R311	PR0805	R311	30A5
R312	PR0805	R312	33A5
R313	PR0805	R313	33B5
R314	PR0805	R314	33A5
R315	PR0805	R315	33B5
R316	PR0805	R316	28A2
R317	PR0805	R317	27A5
R318	PR0805	R318	32D3
R319	PR0805	R319	28C5
R32	PR0805	R32	11D5
R320	PR0805	R320	28A5
R321	PR0805	R321	32B3
R322	PR0805	R322	27A5
R323	PR0805	R323	27C5
R324	PR0805	R324	29A5
R325	PR0805	R325	29B5
R326	PR0805	R326	29C5
R327	PR0805	R327	29B5
R328	PR0805	R328	29D5
R329	PR0805	R329	29C5

M49 SERIE TDS

2

0

4

8

IND	A1	11/96
IND	B2	04/97
IND	B2	12/95

REPEREMENTS-CORRECTIONS	
DESIGNATION	FORMAT A2
SCHEMA DE PRINCIPAL	CARTE-CALCULATEUR
SCHEMA DE PRINCIPAL	?

ETABL	NOM	DATE	VERIFIE	NOM	DATE

NUMERO DE DOCUMENT	IND
2162200219	B2
FEUILLE	sur
37	

M49 SERIE TDS

CE DOCUMENT EST LA PROPRETE DE LA MAISON IL NE POUR ETRE REPRODUIT OU COMMUNIQUE SANS AUTORISATION ECRIE

Z38	93C46	12A5
Z39	TL7757508	11D5
Z4	HCT32	6D4 6C3 6C4 11D3
Z40	MAX875	37C2
Z41	TL7757508	31D2
Z5	HCT04	11D3 11A2 11A2 12C4 12C6 13D5
Z6	HC4020	12B5
Z7	HCT14	6D5 6A5 6A4 6A2 10C4 18C3
Z8	HCT02	12C2 12B2 13C4 13A4
Z9	HCT4	6C4 12B3
Z900	LM293150	37B2
Z901	HCT4	14D5 14C4

VALABLE
POUR FABRICATION

R913	PR0805	14C4
R914	PR0805	14D4
R915	PR0805	13B3
R916	PR0805	25B4
R917	PR0805	11B5
R918	PR0805	11B5
R919	PR	30B5
R92	PR0805	33C4
R920	PR	30C5
R921	PR	30B4
R922	PR	30C4
R923	PR0805	36B2
R924	PR0805	36B3
R93	PR0805	33C4
R94	PR0805	29A5
R95	PR0805	29A5
R96	PR0805	29B5
R97	PR0805	29B5
R98	PR0805	29C5
R99	PR0805	29D5
SST1	ETOILE	5C3
SST2	ETOILE	8D5
SST200	ETOILE	5D5
SST6	ETOILE	11C5
T1	TRANSEPI3A45	37A3
Y1	QUARTZ3P	11A6
Y2	QUARTZ3P	31B3
Z1	TL7726	7A3
Z10	HC03	15B4 16D2 16D5 17C2
Z100	HCT573	12A3
Z11	HC03	16B5 16A2 17C4 17B4
Z12	HC03	15A4 16C5 16A5 17D2
Z13	HC03	15D4 15C4 17D4 17B2
Z14	HCT573	12A3
Z15	HC14	31D6 31C6 31C6 31B5 36C4 36B4
Z16	HCT04	28C4 28C2 26B4 26B2 20A5 28A2
Z17	78134	31A2
Z18	HCT04	20A2 27C4 32D6 32B6 33D5 36C4
Z19	HCT00	32D5 32C5 32B5 32A5
Z2	UPD78324FP	11A4
Z20	HC4020	33C5
Z21	LM2903	27B4 27A4
Z22	2844D	37B5
Z23	HCPL0611	20C4
Z24	HCPL0611	20B4
Z25	HCPL0611	20A4
Z26	MOC206	19A4
Z27	MOC206	19B4
Z28	MOC206	19C4
Z29	HC03	34D3 34C3 34B3 34A3
Z3	HC08	6C2 18C4 18C4 18B4
Z30	HC74	26C5 26B5
Z31	TL7757508	26C3
Z32	HC10	24B4 24B4 26D5
Z33	HC14	24B3 24B3 26D5 26C5 35C5 35C5
Z34	LM2903	26C2 35A3
Z35	HC4020	35C4
Z36	HC74	35C2 36A4
Z37	LM2903	13B5 16A4

M49 SERIE TDS

216224132

19

1

SCHEMA DE PRINCIPALE

SCHEMA DE PRINCIPALE

IND	A	12/95
DATE	A1	12/95
REVISIONS-CORRECTIONS	A2	01/97
	A3	01/97
	A4	04/97
	A5	06/97

DESIGNATION	CARTE_HACHEUR	
ENSEMBLE	ENSEMBLE	
FORMAT	A2	
DATE	12/95	
IND	A	

DRAWING: TITRE=HACHEUR
 ABBRE=HACHEUR
 FRI Mar 7 14:22:58 1997

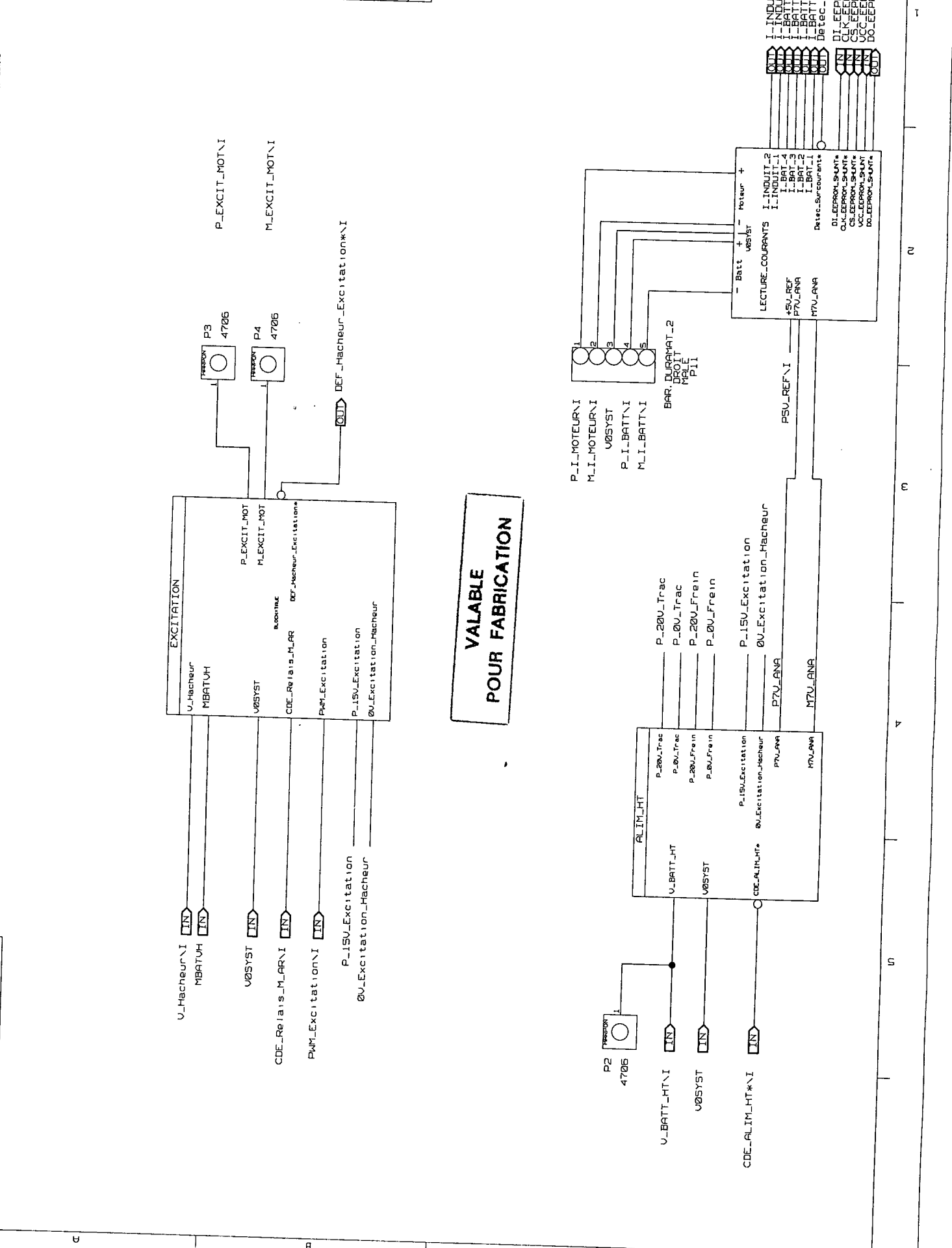

VALABLE POUR FABRICATION

SCHEMA DE PRINCIPALE

SCHEMA DE PRINCIPALE

IND	A	12/95
DATE	A1	12/95
REVISIONS-CORRECTIONS	A2	01/97
	A3	01/97
	A4	04/97
	A5	06/97

DESIGNATION	CARTE_HACHEUR	
ENSEMBLE	ENSEMBLE	
FORMAT	A2	
DATE	12/95	
IND	A	

DRAWING: TITRE=HACHEUR
 ABBRE=HACHEUR
 FRI Mar 7 14:22:58 1997

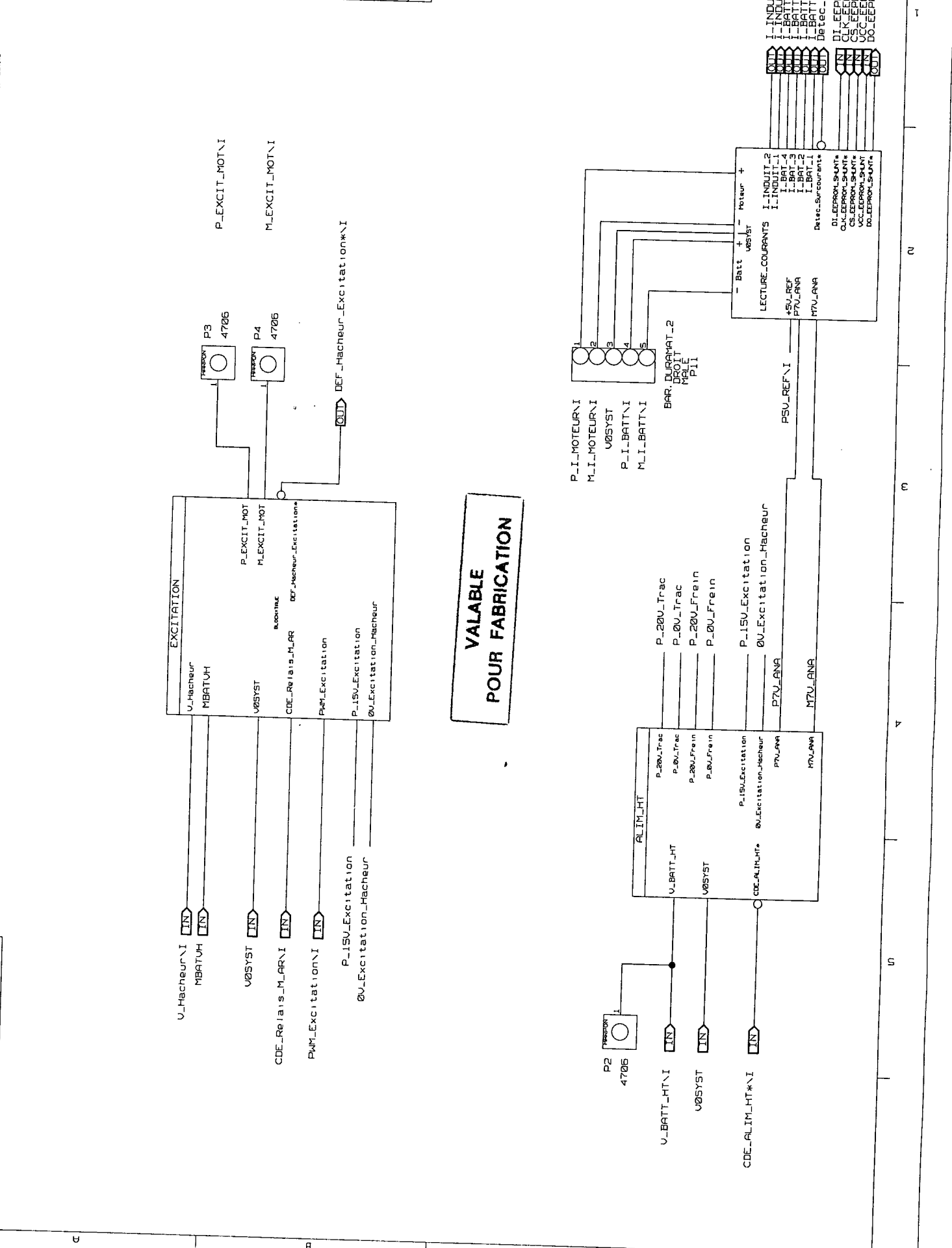

VALABLE POUR FABRICATION

SCHEMA DE PRINCIPALE

SCHEMA DE PRINCIPALE

IND	A	12/95
DATE	A1	12/95
REVISIONS-CORRECTIONS	A2	01/97
	A3	01/97
	A4	04/97
	A5	06/97

DESIGNATION	CARTE_HACHEUR	
ENSEMBLE	ENSEMBLE	
FORMAT	A2	
DATE	12/95	
IND	A	

DRAWING: TITRE=HACHEUR
 ABBRE=HACHEUR
 FRI Mar 7 14:22:58 1997

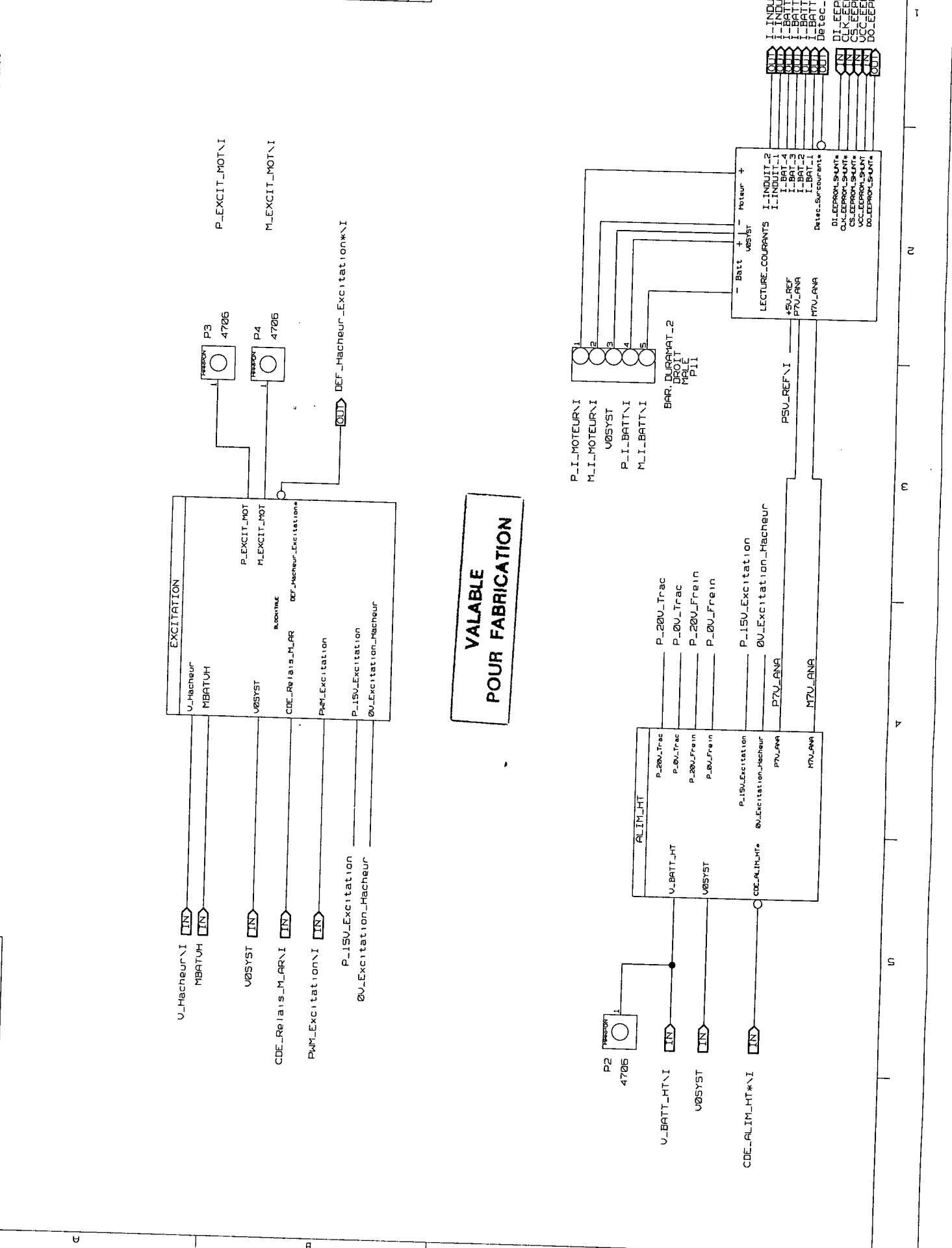

VALABLE POUR FABRICATION

